

TBV02104B  
( 3-way )

TBN01103B  
( Valve Cartridge )



TBV02104B  
TBN01103B

### FEATURES

- Elegant appearance.
- Beautiful curves reveal elegant taste.
- Easy installation and usage.

### SPECIFICS

Water Inlet Requirement :  
0.05MPa(Dynamic  
Pressure)~1.0MPa(Static  
Pressure)

### TBV02104B+TBN01103B Wall-Mount Diverter Panel

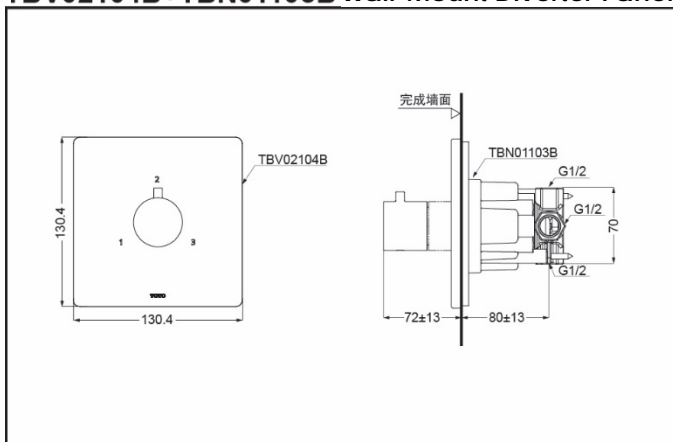

\*TOTO(CHINA) CO.,LTD. All rights reserved.

### Others

Series : G  
Recommend fittings :  
G series Shower