

TBV02102B
(3-way with Off)

TBN01101B
(Valve Cartridge)



TBV02102B
TBN01101B

FEATURES

- Elegant appearance.
- Beautiful curves reveal elegant taste.
- Easy installation and usage.

SPECIFICS

Water Inlet Requirement :
0.05MPa(Dynamic
Pressure)~1.0MPa(Static
Pressure)

TBV02102B+TBN01101B Wall-Mount Diverter Panel

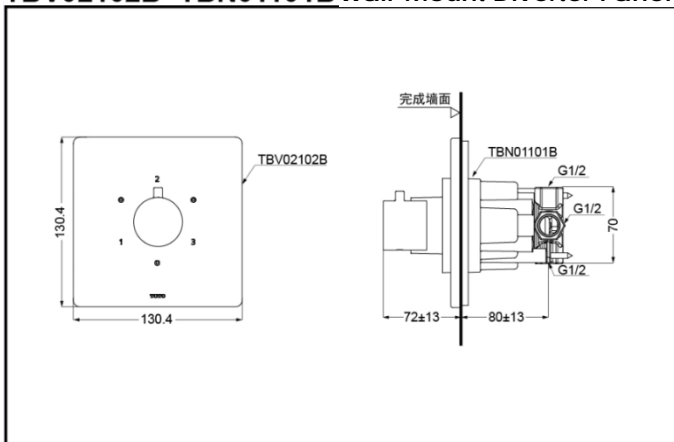

*TOTO(CHINA) CO.,LTD. All rights reserved.

Others

Series : G
Recommend fittings :
G series Shower