

TBV01101B
(1-way with Off)

TBN01104B
(Valve Cartridge)



TBV01101B
TBN01104B

FEATURES

- Elegant appearance.
- Beautiful curves reveal elegant taste.
- Easy installation and usage.

SPECIFICS

Water Inlet Requirement :
0.05MPa(Dynamic
Pressure)~1.0MPa(Static
Pressure)

TBV01101B+TBN01104B Wall-Mount Diverter Panel

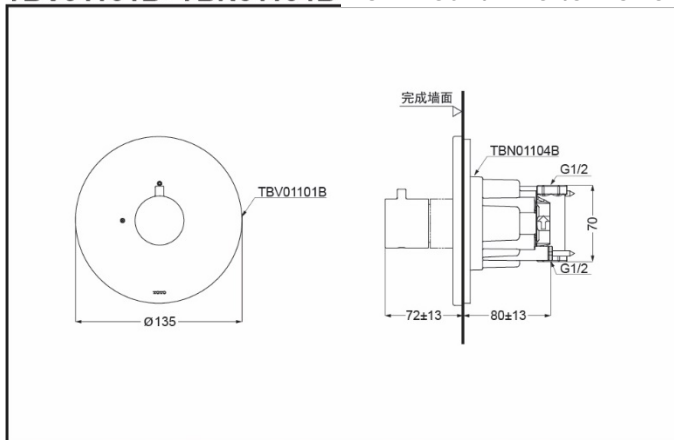

*TOTO(CHINA) CO.,LTD. All rights reserved.

Others

Series : G
Recommend fittings :
G series Shower