

TOTO



2026-2027 GENERAL CATALOGUE

TOTO 2026-2027 GENERAL CATALOGUE

综合样本



TOTO样本集

A new world. A better way to clean.

TOTO

智能坐便系列 诺锐斯特®
SMART TOILET -NEOREST®-

智能坐便系列 卫洗丽®
SMART TOILET -WASHLET®-

轻智能版
SMART TOILET LITE

坐便器
TOILET

台盆柜
BATHROOM CABINET

洗面器
LAVATORY

水嘴花洒
FAUCET & SHOWER

浴缸
BATHTUB

公共产品
PUBLIC

其他
OTHERS

推荐组合
RECOMMEND

索引
INDEX

TOTO效果&技术 Benefits & Technologies

智能洁净系统技术



洁净喷雾
PREMIST
便器内壁喷雾防污技术



智洁
CEFIONTECT
纳米抗污釉面技术



极漩
TORNADO FLUSH
360°漩涡式冲洗技术



RIMLESS
内壁易洁结构设计



智净
EWATER+for BOWL
便器内壁电解水除菌技术



智净
EWATER+for UNDER SEAT
便圈底部电解水除菌技术



智净
EWATER+for WAND
喷嘴电解水除菌技术

其他先进技术



韵波
AIR-IN WONDER WAVE
空气注入式水珠洗净技术



AERIAL PULSE
空气按摩式出水技术



雨跃
INTENSE WAVE
劲醒水流淋浴技术



智炫
ACTILIGHT
光触媒清洁技术



ECO CAP
水嘴气泡吐水技术



雨沁雾
MIST SPRAY SHOWER
清洁水雾淋浴技术



AUTO FUNCTIONS
便器自动冲洗技术



雨温
WARM SPA
温暖水柱淋浴技术



舒芯
COMFORT GLIDE
舒适耐用水嘴阀芯



REDUCE THE WATER
节水技术



雨温
WARM SPA
温暖水柱淋浴技术



安心触
HEAT PROTECT
水嘴防烫保护技术



WARM AIR DRYING
暖风干燥技术



AERIAL HANDSHOWER
手持花洒水气泡吐水技术



水旋
GYROSTREAM
水流旋转式淋浴技术



HEATED SEAT
便盖保温技术



雨幻
COMFORT WAVE
充沛水流淋浴技术



SAFETY THERMO
智能恒温技术



DEODORIZER
除臭技术



雨悦宁
CALMING SHAWL
环绕水流淋浴技术



百灵盒
MINI UNIT
面板自由组合技术



ECOPOWER
水力发电技术



雨幻
COMFORT WAVE
充沛水流淋浴技术



水魔力
HYDROHANDS
魔力按摩浴缸技术



纤翼
LINEARCERAM
轻薄陶瓷材质



雨醒
ACTIVE WAVE
动能水珠淋浴技术



纤浮
ZERO DIMENSION
太空眠入浴技术



纤雨
SOFT FLOW
水嘴柔和出水技术



雨跃
INTENSE WAVE
劲醒水流淋浴技术



悠浮
RECLINE COMFORT
漂浮仰浴技术

国际设计大奖 About Global Design Awards



iF设计奖

自1953年以来持续至今的国际性权威设计大奖。由德国汉诺威的iF国际论坛设计有限公司主办。由设计专家们对美观性、功能性及创新性进行严格公正的审查，评选出公认的优秀产品。



red dot award
product design

红点设计奖

自1955年以来持续至今的国际性权威大奖。由德国埃森的设计协会Zentrum Nordrhein Westfalen主办。由设计专家们对创新性、功能性及产品品质进行严格公正的审查，评选出公认的优秀产品。



red dot winner 2021
best of the best

红点最佳设计奖

从红点奖获奖产品中挑选出特别优秀的产品授予此奖，获奖率不到2%。



绿色优秀设计奖

由美国芝加哥雅典娜建筑设计学院和爱尔兰欧洲建筑设计城市研究中心主办。于2009年开始的世界性环保奖。旨在通过绿色设计进行生态环保意识改革。

目录 CONTENTS

智能坐便系列 SMART TOILET 018

效果&技术 BENEFITS&TECHNOLOGIES

- 020 智能洁净系统
- 036 诺锐斯特®的先进技术
- 040 健康度
- 044 清洁度
- 046 人本关怀
- 047 可持续发展（环保性能）

诺锐斯特® NEOREST®

- 048 诺锐斯特®智能全自动一体型电子坐便器

卫洗丽® WASHLET®

- 076 卫洗丽®技术一览
- 078 卫洗丽®智能一体型坐便器推荐产品
- 080 卫洗丽®智能一体型坐便器
- 084 卫洗丽®智能组合坐便器推荐产品
- 086 卫洗丽®智能组合坐便器
- 092 卫洗丽®智能冲洗坐便盖

轻智能版 SMART TOILET LITE

- 096 智能一体型坐便器轻智能版

坐便器 TOILET 098

- 101 连体式坐便器
- 102 分体式坐便器
- 103 隐藏式水箱坐便器
- 104 水箱及面板

台盆柜 BATHROOM CABINET 110

- 120 陶瓷一体型台盆柜
- 124 挂墙款台盆柜（含一体式陶瓷洗面器）
- 126 深型陶瓷台盆柜
- 127 镜柜

洗面器 LAVATORY 132

- 134 洗面器推荐产品
- 136 晶雅石材质洗面器
- 137 桌上式洗面器
- 139 台下式洗面器
- 140 半埋入台上式洗面器
- 140 立柱式洗面器
- 141 壁挂式洗面器
- 141 洗手盆

水嘴花洒 FAUCET & SHOWER 148

水嘴 FAUCET

- 150 TOTO的先进技术
- 156 ZA系列
- 160 ZL系列
- 166 GE系列
- 170 GC系列
- 174 GM系列
- 178 GT系列
- 182 GB系列
- 186 GA系列
- 190 GF系列
- 194 GS系列
- 198 GO系列
- 202 GR系列
- 206 LH系列
- 208 LB系列
- 210 LN系列
- 212 LC系列
- 214 LF系列

花洒 SHOWER

- 218 TOTO的先进技术
- 242 Z系列淋浴柱
- 244 Z系列花洒
- 246 G系列花洒
- 248 L系列花洒
- 250 智能恒温系列

- 252 浴室产品
- 262 埋入盒装本体部
- 264 恒温淋浴水嘴阀体 & 面板
- 265 其他淋浴水嘴阀体 & 面板

- 270 卡塞尔水嘴系列
- 272 拉菲斯水嘴系列
- 274 伊娜水嘴系列
- 276 C II 水嘴系列
- 286 浴缸用水嘴
- 287 洗面器用水嘴
- 289 厨房用水嘴
- 290 其他水嘴

浴缸 BATHTUB 292

- 294 漂浮感浴缸
- 302 晶雅石材质浴缸
- 304 珠光材质浴缸
- 308 亚克力浴缸

公共产品 PUBLIC 316

- 318 公共产品推荐产品
- 320 自动感应水嘴
- 325 自动感应皂液器
- 326 自动感应水嘴用小型电热水器
- 328 公共坐便器
- 331 小便器
- 332 大便器冲洗阀
- 333 小便器冲洗阀
- 334 小便器下方专用陶板（海洁特净悦板）
- 336 全自动烘手器

- 338 其他陶瓷品及配件
- 340 升降式坐便辅助器（带扶手）
- 341 升降式/壁挂式洗面器
- 342 福祉产品
- 345 婴幼儿产品
- 346 儿童产品

其他 OTHERS 348

- 350 浴室取暖干燥机（三干王）
- 352 配件

推荐组合 RECOMMEND 360

历史 HISTORY 388

集团理念 TOTO GROUP STRATEGY 389

索引 INDEX 390

"WASHLET", "WASHLET" 和 "卫洗丽" 是 TOTO 株式会社 "智能冲洗坐便盖" 等的注册商标。



TOTO

Life Anew

唯及智 方尽美

TOTO

Life Anew

唯及智 方尽美

“希望提供健康且富有文化气息的生活。”

我们怀着创业以来的心愿，持续致力于各种各样的活动。

一切都是为了打造获得顾客与社会信任的企业。

我们希望面向连接未来的“明天”，通过对人与地球的关怀，

创造与过去“不同”的价值，

呈上超过世人期待的“每一天”。

我们将通过 TOTO 集团所有人的力量来实现。

TOTO 智臻致净

净，是一种让内心平静的力量。

净，是一种美好生活的向往。

净，是为了让生活焕然一新。

净，更是对人类和地球家园的关心。

净，为我们创造每天的健康生活。

TOTO智臻致净，将超出想象的洁净体验带入千家万户。

让每天的生活洁净如新，时刻充满生机。



TOTO智臻致净

智臻至美 更净一步



前沿科技融汇精湛设计。
让舒适与幸福，
流淌在生活的每个瞬间。
源自对科学的追求，
和呵护健康的执着信念，
让每天的身心都充满洁净的能量。
悦然生活，崭新境界。
尽在诺锐斯特。

智臻奢华 悦然新境

A woman with short dark hair, wearing a long-sleeved white dress with a cinched waist, stands on a balcony or terrace. She is looking out at the ocean with a smile, her right hand raised slightly. The background is a vast expanse of blue water under a clear sky. In the foreground, a modern, white toilet is visible, suggesting a high-end bathroom setting. The overall atmosphere is serene and luxurious.

PURE LUXURY

智臻奢华 悦然新境

NEOREST[®]



清洁技术

保持持久清洁，让你
使用更为安心

智能坐便系列 效果&技术

TOTO BENEFITS & TECHNOLOGIES

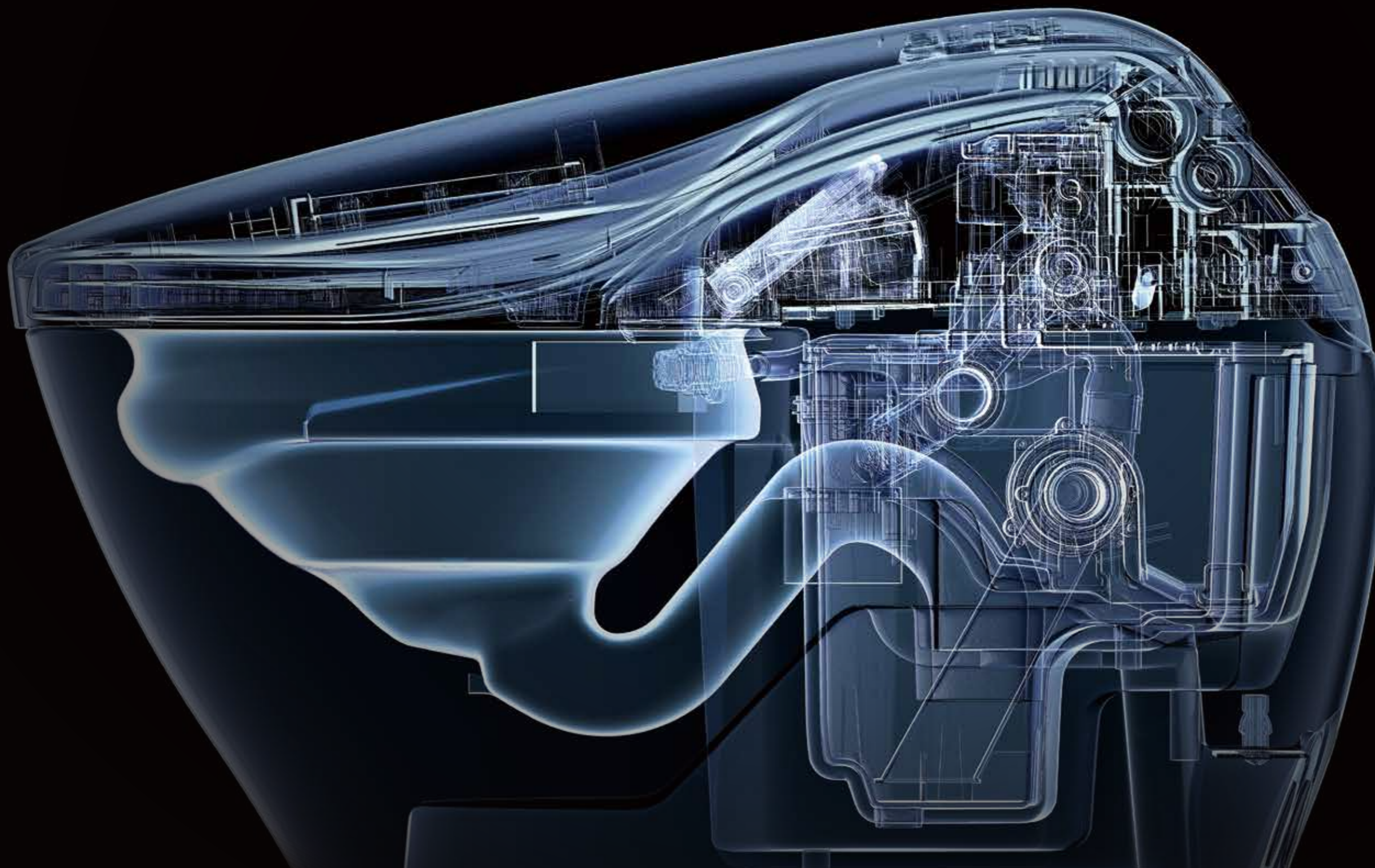



洁净喷雾
PREMIST
便器内壁喷雾防污技术



智洁
CEFIONTECT
纳米抗污釉面技术



极漩
TORNADO FLUSH
360°漩涡式冲洗技术



RIMLESS
内壁易洁结构设计

智能洁

自动清洁 每次



智净
EWATER+ for WAND
喷嘴电解水除菌技术



智净
EWATER+ for BOWL
便器内壁电解水除菌技术



智净
EWATER+ for UNDER SEAT
便圈底部电解水除菌技术

净系统

都是全新体验

洁净喷雾

PREMIST

污垢浮在陶瓷表面
难以粘附



便器内壁喷雾防污技术



每次使用前，都将会在便器内壁上喷洒水雾。利用陶瓷的亲水性，使污物更易清洗干净。

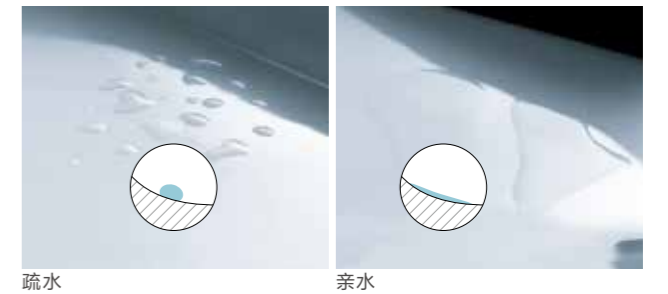

“智洁”坐便器拥有良好的亲水性

亲水性这个词经常被用来表达材料与水良好交融的状态。“智洁”坐便器正是这样一种具有亲水性的产品。冲洗坐便器时，水流迅速覆盖坐便器内壁，冲洗污垢更加轻松。

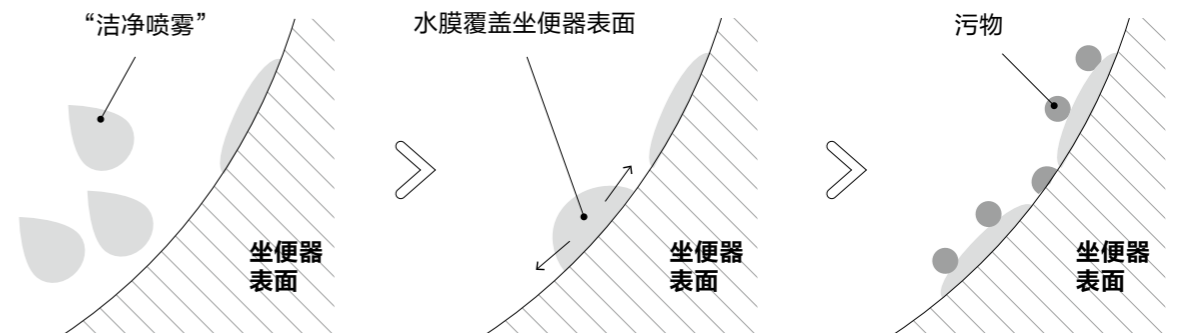

智洁

CEFIONTECT

污垢容易冲落



纳米抗污釉面技术

超平滑陶瓷表面，
洁净不易留痕。

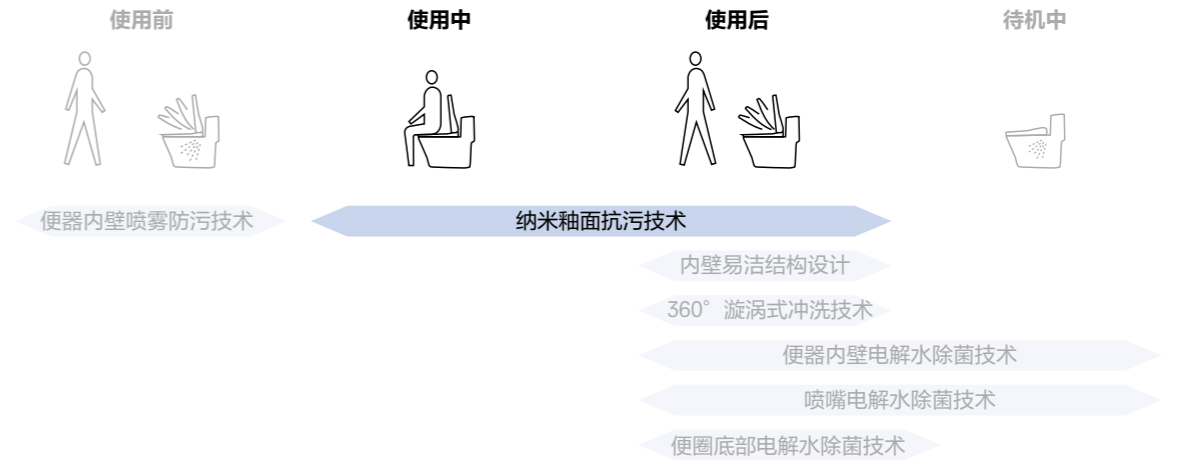

“智洁”坐便器的内壁采用了特别的陶瓷釉面，超平滑的陶瓷釉面几乎不给污垢容身的空隙。“智洁”坐便器能够保持内壁长久洁净，经久耐用。

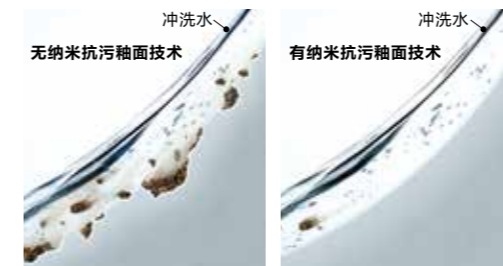

冲洗时坐便器表面的断面放大示意图

减少容易藏污纳垢的陶瓷表面凹凸

普通陶瓷釉面看上去也许非常光滑，但其实存在肉眼看不见的凹凸，污垢、霉菌、细菌容易藏身其中。采用“智洁”的坐便器内壁，釉面空隙小到纳米水平，几乎不给污垢容身空间。

是什么造就了“智洁”坐便器出色的耐久性？

常规釉面之上附加烧制了一层玻璃质层，这使得“智洁”产品具有了经久耐用的品质。

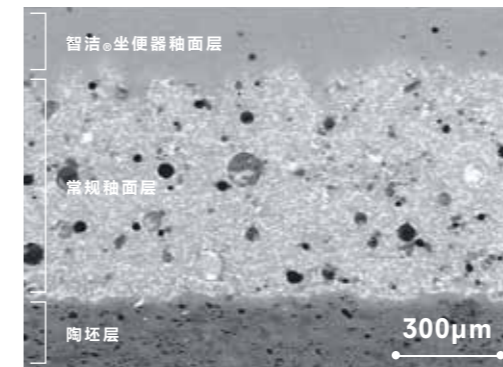

智洁坐便器的显微镜照片

“智洁”坐便器拥有良好的亲水性

亲水性这个词语经常被用来表达材料与水良好交融的状态。“智洁”坐便器正是这样一种具有亲水性的产品。冲洗坐便器时，水流迅速覆盖坐便器内壁，冲洗污垢更加轻松。

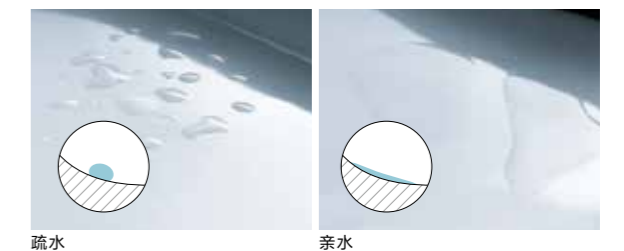

RIMLESS

无死角内壁
污垢细菌无处藏身
便于打扫



内壁易洁结构设计

打扫坐便器变得更为轻松，
更重要的是污垢、细菌无处藏身



特别的无棱内壁设计，让污垢、细菌难以藏身，更重要的是打扫坐便器变得更为轻松。

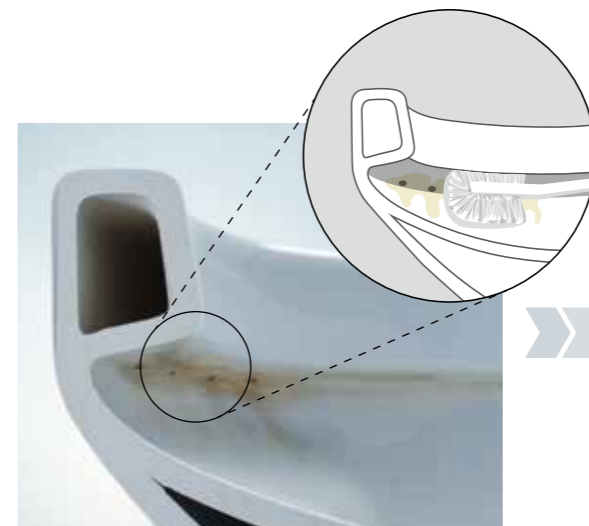

以往便器内壁的出水小孔设计使污垢容易堆积，
长时间使用后会形成黄斑，难以祛除。

* 此处以往便器是指我以往部分型号产品



便器内壁可见，一眼就能确认污垢，
打扫无死角。

极漩

TORNADO FLUSH

漩涡式强劲冲洗



360°漩涡式冲洗技术

360°强劲水流，全方位冲洗、
高效节水冲洗。



360°漩涡式冲洗技术在确保高效冲洗的同时，还实现了节水。强劲的水流形成360度旋流，全方位冲洗无棱坐便器内壁。



**强力冲洗，
有效清除易残留污物**

坐便器出水口释放出旋转式的动态水流，沿无棱内壁回旋数周，以恒势水压清除最易积累污物的区域，再将这个内壁冲洗干净。优质陶瓷让这项创新设计变成可能。

智净

EWATER+ for BOWL

去除粘附在
坐便器上的细菌



便器内壁电解水除菌技术

电解除菌水轻松分解污物，
污垢难以残留。



喷嘴和坐便器内壁容易受污垢、细菌污染，难免出现黑斑。电解除菌水能够对喷嘴和坐便器内壁进行清洁除菌。不添加化学物质和清洁剂，让您每天都能放心使用。

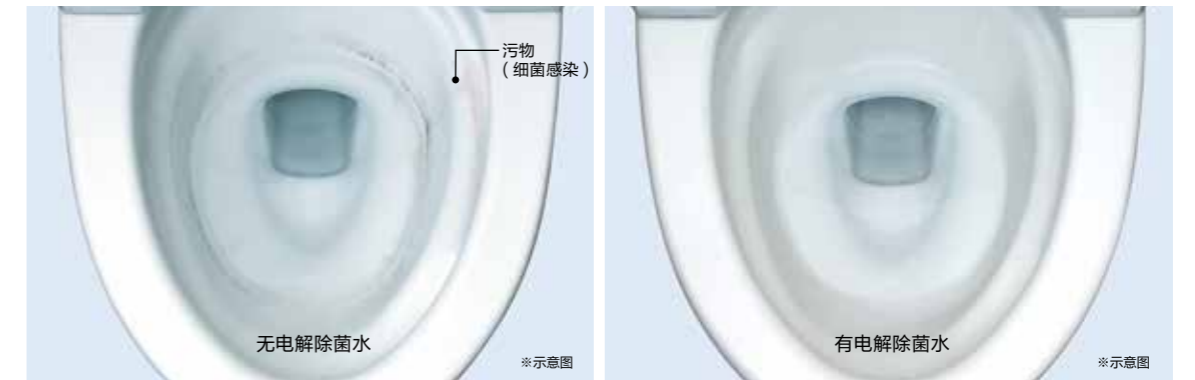

实验方法：为研究电解除菌水的效果是否显著，采用未经清洁的坐便器与使用电解除菌水自动清洁的坐便器进行比较，并观察洁净效果。（实验期间禁止清洗坐便器。）

实验周期：一个月（2017年2月-3月）。对象：4个家庭。

*使用效果因环境而异。所有实验数据由TOTO收集。

什么是电解除菌水？

普通生活用水经过电解后形成电解水，电解水所含的次氯酸成分，具有除菌作用。整个过程不添加化学药品和清洗剂。一定时间后，电解除菌水会自动还原成普通水，自然、环保。



智净

EWATER+ for UNDER SEAT



便圈底部电解水除菌技术

去除便圈底部前端的污垢及细菌，保持清洁



为了保持清洁，每次使用，对容易沾染污垢的便圈前端背面区域进行电解除菌水喷雾。对尿渍等污垢可以起到抑制泛黄、保持长久清洁的效果。清扫前，可开启手动喷雾功能，轻轻擦拭即可轻松去除污垢。

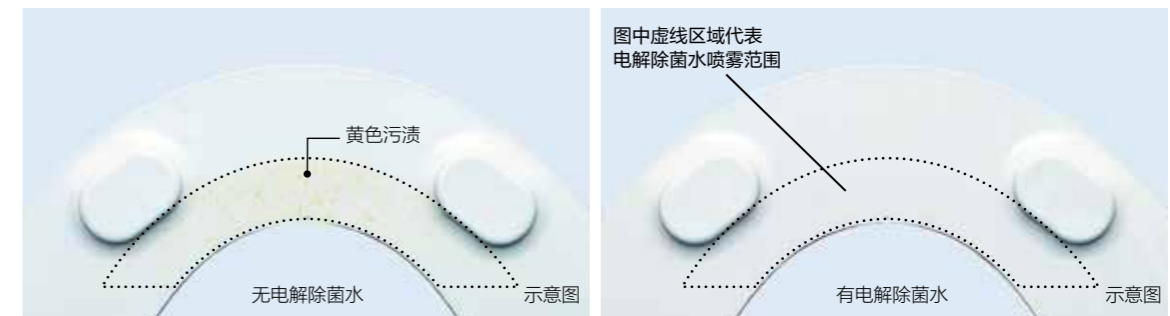

试验方法：对采用便器底部电解水除菌技术的产品和无此功能的产品进行测试
 试验条件：模拟 4 名家庭成员、正常使用 2 周，不清扫的情况下
 ※ 因使用·环境条件的不同，效果会有所差异（TOTO 测试）

什么是电解除菌水？

普通生活用水经过电解后形成电解水，电解水所含的次氯酸成分，具有除菌作用。整个过程不添加化学药品和清洗剂。一定时间后，电解除菌水会自动还原成普通水，自然、环保。



电解除菌水喷洒便圈下方

电解除菌水喷洒在整个坐便器内壁，小的水滴被气流吹送到便圈前端背面区域（便圈底部电解水除菌技术），大的水滴覆盖在坐便器内壁表面（便器内壁电解除菌水技术）。

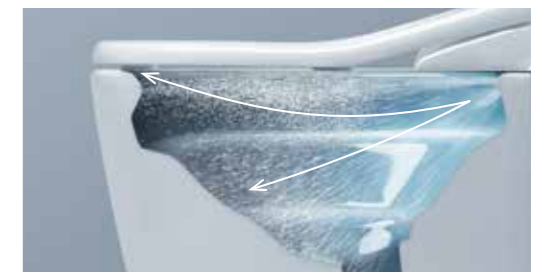

智净

EWATER+ for WAND

去除粘附在
喷嘴上的细菌



喷嘴电解水除菌技术

电解除菌水进行自动清洁后，
喷嘴内外洁净如一，
使用更安心。



每次使用前后，电解除菌水都会对喷嘴内外侧进行清洁除菌。即使在没有使用时，也会定期进行喷嘴自清洁，始终保持良好的洁净状态。

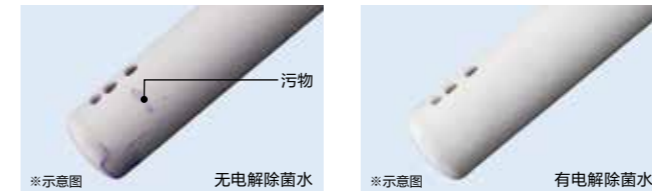

实验方法：为研究电解除菌水效果是否显著，采用有电解除菌水功能的自清洁喷嘴与普通自清洁喷嘴进行比较，并观察洁净效果。（实验期间禁止清洗坐便器。）
实验周期：两个月（2017年9月-10月）。
对象：4个家庭。

*根据使用情况、环境条件以及产品类型不同，实验结果略有不同。所有实验数据由TOTO收集。

什么是电解除菌水？

普通生活用水经过电解后形成电解水，电解水所含的次氯酸成分，具有除菌作用。整个过程不添加化学药品和清洗剂。一定时间后，电解除菌水会自动还原成普通水，自然、环保。



对喷嘴内侧也进行自动除菌



电解除菌水还会对喷嘴内部、外部进行清洁除菌



即使长时间不使用，也会定时进行清洁，保持坐便器干净卫生

漩动力

HYBRID ECOLOGY SYSTEM

双重高效冲洗系统

“漩动力”，水箱式冲洗加上管道直压水流冲洗，双效叠加，形成两股强劲水流，极大地提高了冲洗力。用少量的水就能有效清除污物，还无需二次冲洗清洁。即使在高层建筑中，冲洗力依然出众。



* 进水要求: 0.05MPa(动压)-0.75MPa(静压)

智炫

ACTILIGHT

创新的卫浴清洁技术，
炫洁闪耀的光滑表面，
光触媒技术轻松分解污垢。

光触媒清洁技术

拥有先进科技含量的材料

氧化钛使坐便器内壁保持亲水状态，为实现光触媒作用做好了铺垫。光触媒层含有氧化锆，能够带来良好的耐久性。

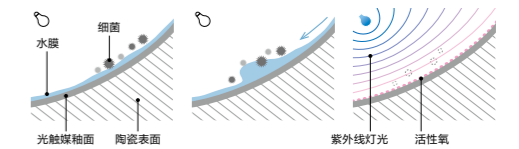

24 小时运作，时刻保持洁净状态

通过紫外线光照和釉药产生光触媒反应，由周围的氧气和水分子生成活性氧。活性氧可以有效分解并减少污垢、细菌的产生。

智净

AIR DEODORIZER

空气焕新电解水技术

自动去除卫生间空气中的臭味。将便器中所产生的臭味的细菌源进行分解和去除，再加上“智净”的双重保护，将更好地抑制卫生间臭味的产生。

* 对于气味的感知，因个人差异·身体状况·环境条件等，会有所不同。

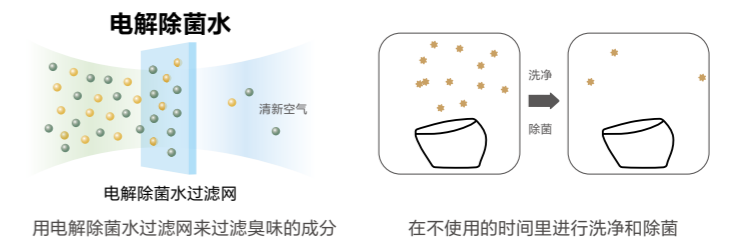

用电解除菌水过滤网来过滤臭味的成分

在不使用的时间里进行洗净和除菌

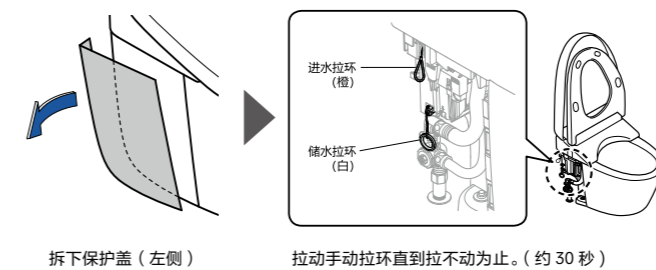

停电手动冲洗

因停电无法进行冲水处理时（非断水时）

（停电时冲洗便器用）拉动手动拉环，便器内的水可以流出。通电情况下，即使拉动手动拉环，也不能冲洗便器。想要确认该功能时，请先关掉配电箱的总电源。

洗净技术

全新的清洁方式，为你
实现健康、美好的生活

韵波

AIR-IN WONDER-WAVE



空气注入式水珠洗净技术

充满气泡的舒适水流
保持时刻温暖、
让心情愉悦。

饱含气泡的水珠带来更加舒适的清洗感受，节水并有效清洁。而且采用即时加热的方式，不用担心出现温水间断的情况。

洗净模式



每次如厕后，卫洗丽会喷出温水，以适度的水流，完成洗净，水滴中饱含空气，更加舒适。



充沛水量的喷雾式出水，以柔和的水流，轻柔地完成臀部清洗，细致洗净，更加舒适。



混有气泡的水流，轻柔温和，呵护女性健康。



全面清洗女性下身，冲洗范围更广、水流更柔和，在特殊的日子给予特别的关怀。



前后摆动洗净

Oscillating Cleansing

喷头可前后摆动，扩大洗净范围，提升洗净效果。



按摩洗净

Pulsating Cleansing

律动式水流，通过水势的强弱变化，给您带来如同按摩般的水洗感受。



洗净位置自由调节

Wand Position Adjustment

根据个人喜好调节喷头的洗净位置，满足不同人的所需。

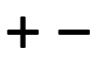

水流调节

Water Pressure Adjustment

具有5档水流调节功能。

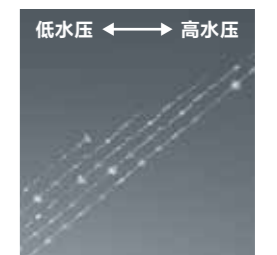



舒适技术

为你和你所爱之人奉上
舒适、丰富的生活

卫洗丽®智能坐便盖与坐便器之间缝隙减少

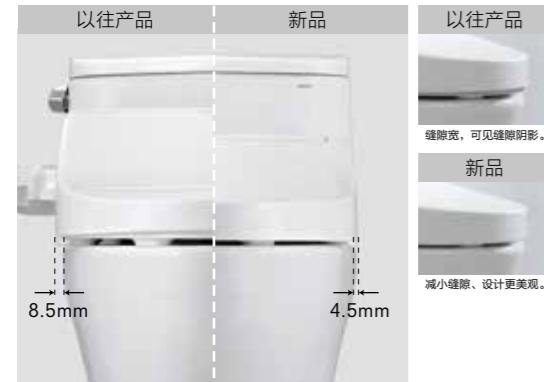

卫洗丽®智能坐便盖减少了与坐便器的缝隙，创造出外观简约的一体感设计，营造简洁干净的空间。
*此处以往产品是指我司以往部分型号产品

坐便盖无缝设计

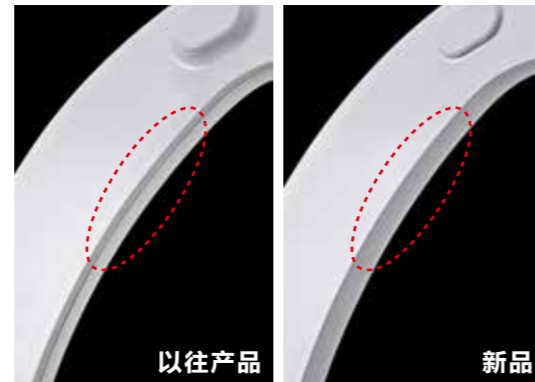

坐便盖无缝设计，不易结垢、污垢可以轻松清扫。
*对象商品：诺悦斯特® NX、WX、LS、AS、RS
卫洗丽® G5A、G5N、W7、S7、S5、S2
*此处以往产品是指我司以往部分型号产品

坐便盖缓冲垫无接缝设计

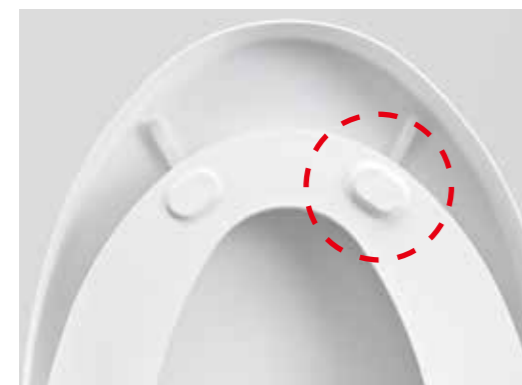

坐便盖缓冲垫无接缝设计，污物不易残留，方便清扫。

便盖造型设计优化

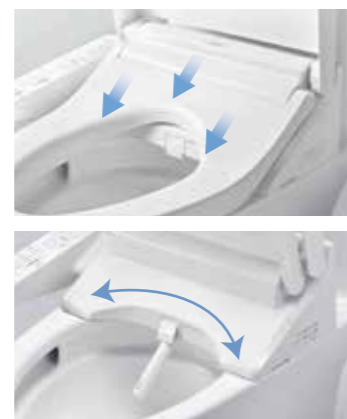

坐便盖部件设计减少高低差，简洁的外观设计，更方便使用和擦拭。

坐便盖更容易粘附污物的地方外观设计简约，使清扫更轻松。

洁净材质

选用优质树脂，不但可以防止污物粘附，还能防止材质变色，更好地保持表面持久洁净。



易清洁设计

普通边缘有棱的坐便器一直存在容易藏污纳垢、难以清洁等问题，这款坐便器不但采用了无棱结构设计，喷头收纳处的设计也很人性，打扫简单轻松。



可以方便地将卫洗丽拆卸下来。这样就可以轻松对安装接触部、边缘缝隙等平时难以打扫的地方进行清洁。



一键装卸

可以方便地将卫洗丽从坐便器上拆卸下来。坐便器与卫洗丽的安装面、坐便器与水箱的接触面等难以擦拭的地方也可以轻松进行打扫。

*保养维护等过程中需将卫洗丽主体拆卸下来时，请务必将电源插头从插座中拔出。



持久洁净

持久洁净，便捷清洗

选用优质耐污树脂制造，并在每次使用后会自动喷出电解除菌水，使清洁喷嘴能抵抗污物与污渍。更重要的是，清洁喷嘴安装在坐便盖上，而非坐便器中，喷嘴很难沾染污渍。尽管喷嘴带有自清洁功能，您依然可以轻松清理喷嘴，将它擦拭干净。

*喷出电解除菌水需搭载此技术产品

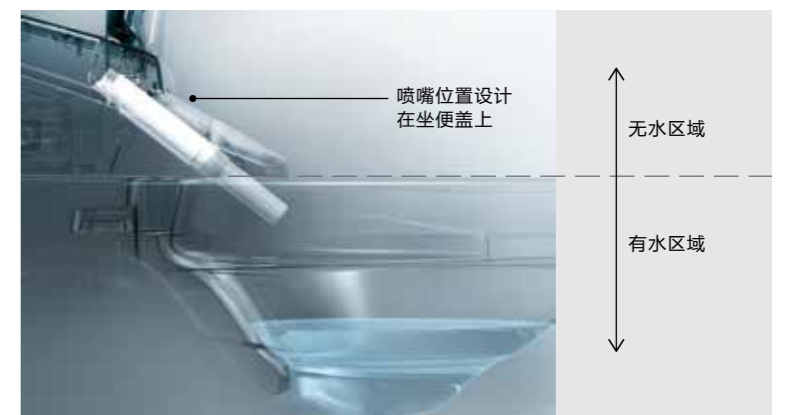

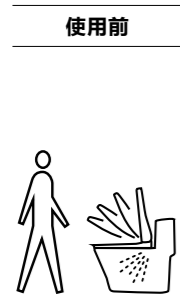

便盖自动开闭技术

无需接触坐便器表面，接近或离开坐便器时便盖自动开闭。

柔光照明

人靠近就亮起柔和的照明，夜间不会再受洗手间灯光过于晃眼的困扰。

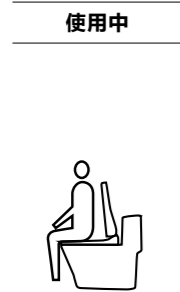

便盖保温技术

当您入座时，坐便盖会快速升温，达到舒适温度。



除臭技术

使用中以及使用后坐便器内自动启动高效除臭功能，不留异味。

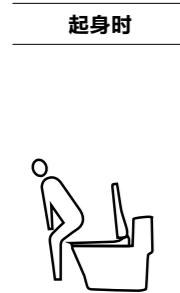

便器自动冲洗技术

无需触碰按钮或把手，也无需担心他人用后忘记冲洗，每次使用后会进行自动冲洗。

TOTO 智能坐便系列，搭载智能洁净系统，无需使用化学清洁剂，只需少量用水，即可完成清洁。

先进的型号，一次冲洗只需 3.8L 水，特别的无棱内壁设计，清洁打扫更为方便。TOTO 智能坐便系列，让您生活清洁、卫生的同时，更节约资源，保护地球环境。



高效节水

一次冲洗用水量仅需 3.8L，虽然用水量减少，但不用担心，360°漩涡式冲洗技术会为您保持强力的冲洗力。自动冲洗功能会自动判断大小冲洗，不会浪费水。

节水技术

ECOMAX 产品集成了 TOTO 开发的一系列节水技术，包括超级节水技术、纳米抗污釉面技术。在这些技术的作用下，TOTO 为您制造出冲水量 4.8L 及以下的超级节水坐便器。

ECOMAX 3.8L

环保进一步节水再升级。节水环保，TOTO 引领行业发展。

ECOMAX DUAD

冲水量 (双档): 3/3.8L 3/4.5L 3/4.8L 3.3/4.8L 3.4/4.8L 3/6L
出色的 360°漩涡式冲洗技术、纳米抗污釉面技术、节水技术，三位一体超强表现，再配合新型的大流量水箱配件，实现双档高效的节水冲洗。

ECOMAX

环保节水产品，单档出水仅为 4.6L。

二次装修对应

即使进水角阀预留距离过远或者二次装修也能完美对应。

NEOREST®LS 系列

标准



LS 可选供水软管用于延长。

供水软管延长



NEOREST®AS, NEOREST®RS 系列

标准



AS/RS 可选供水软管用于更换。

供水软管更换





诺锐斯特®
NEOREST®

NEOREST. RS

NEOREST. AS

NEOREST. LS

NEOREST. NX

NEOREST. WX

诺锐斯特® NEOREST®



NEOREST® NX



智能洁净系统

| | | | |
|------------|----------|----------|-------------|
| | | | |
| 便器内壁防污喷雾技术 | 纳米抗污釉面技术 | 内壁易洁结构设计 | 360°漩涡式冲洗技术 |

| | | |
|-----------|-------------|-------------|
| | | |
| 喷嘴电解水除菌技术 | 便器内壁电解水除菌技术 | 便圈底部电解水除菌技术 |

| | | | |
|-------------|----------|---------|----------|
| | | | |
| 空气注入式水珠洗净技术 | 双重高效冲洗系统 | 光触媒清洁技术 | 便盖自动开闭技术 |

| | | | |
|----------|--------|--------|------|
| | | | |
| 便器自动冲洗技术 | 便盖保温技术 | 暖风干燥技术 | 节水技术 |

- | | | | |
|----------|----------|----------|----------|
| • 喷嘴自清洁 | • 洁净材质 | • 一键装卸 | • 除臭 |
| • 臀部洗净 | • 臀部轻柔洗净 | • 下身洗净 | • 下身护理洗净 |
| • 按摩洗净 | • 摆动洗净 | • 水势调节 | • 洗净位置调整 |
| • 超级自动节电 | • 柔光照明 | • 停电手动冲洗 | |

NEOREST[®] NX



NEOREST® WX



NEOREST[®] WX



NEOREST® LS



造型优雅精致

时尚镍



气质沉稳睿智

优雅黑



NEOREST® AS



NEOREST® RS







NEOREST. NX2 (进口品)
CS903K V3
(坑距 305mm) (镀镍)
CS903K V4
(坑距 400mm) (镀镍)

诺锐斯特®智能全自动一体型电子坐便器
800*480*565mm
EcoMAX DUAL 3L/3.8L 大小切换

智能洁净系统





NEOREST. NX1 (进口品)
CS902 V3
(坑距 305mm) (银色)
CS902 V4
(坑距 400mm) (银色)

诺锐斯特®智能全自动一体型电子坐便器
800*480*565mm
EcoMAX DUAL 3L/3.8L 大小切换

智能洁净系统





NEOREST. WX2
CES9E480GCN
(H=220mm) (镀镍)

MB177M#N
隐藏式水箱面板

诺锐斯特®智能全自动一体型电子坐便器
660*444*367mm
EcoMAX DUAL 3L/4.5L 大小切换

推荐搭配:
隐藏式水箱 WH175BAT
水箱面板 MB177M#N

智能洁净系统





NEOREST. WX1
CES9E780GCN
(H=220mm) (哑光白)

MB177M#W
隐藏式水箱面板

诺锐斯特®智能全自动一体型电子坐便器
660*444*367mm
EcoMAX DUAL 3L/4.5L 大小切换

推荐搭配:
隐藏式水箱 WH175BAT
水箱面板 MB177M#W

智能洁净系统





NEOREST. WX1
CES9E780GCN
(H=220mm) (哑光黑)

MB177M#B
隐藏式水箱面板

诺锐斯特®智能全自动一体型电子坐便器
660*444*367mm
EcoMAX DUAL 3L/4.5L 大小切换

推荐搭配:
隐藏式水箱 WH175BAT
水箱面板 MB177M#B

智能洁净系统



NEOREST. WX1
CES9E380GCN
(H=220mm) (银色)

MB177M#S
隐藏式水箱面板

诺锐斯特®智能全自动一体型电子坐便器
660*444*367mm
EcoMAX DUAL 3L/4.5L 大小切换

推荐搭配:
隐藏式水箱 WH175BAT
水箱面板 MB177M#S

智能洁净系统





NEOREST. LS
CES8E120KCN
(坑距 305mm)
(坑距 400mm)
(坑距 305-435mm) (银色)
CES8E120KCNP
(H=120-130mm) (银色)
CES8G520GCN
(坑距 305mm)
(坑距 400mm)
(坑距 305-435mm) (银色)
CES8G520GCNP
(H=120-130mm) (银色)

诺锐斯特®智能全自动一体型电子坐便器
725*411*497mm
EcoMAX DUAL 3L/3.8L 大小切换

*CES8E120KCNP 冲水量 3L/4.5L

*CES8G520GCNP 冲水量 3L/4.5L

智能洁净系统





NEOREST. LS
CES8G820GCN
(坑距 305mm)
(坑距 400mm)
(坑距 305-435mm) (哑光白)
CES8G870GCN
(H=120-130mm) (哑光白)

诺锐斯特®智能全自动一体型电子坐便器
725*411*497mm
EcoMAX DUAL 3L/3.8L 大小切换

智能洁净系统





NEOREST. LS
CES8G820GCN
(坑距 305mm)
(坑距 400mm)
(坑距 305-435mm) (哑光黑)
CES8G870GCN
(H=120-130mm) (哑光黑)

诺锐斯特®智能全自动一体型电子坐便器
725*411*497mm
EcoMAX DUAL 3L/3.8L 大小切换

智能洁净系统





NEOREST. LS
CES8G220GCN
(坑距 305mm)
(坑距 400mm)
(坑距 305-435mm) (黑色)
CES8G220GCNP
(H=120-130mm) (黑色)

诺锐斯特®智能全自动一体型电子坐便器
725*411*497mm
EcoMAX DUAL 3L/3.8L 大小切换

*CES8G220GCNP 冲水量 3L/4.5L

智能洁净系统







NEOREST. LS
CES8G320GCN
(坑距 305mm)
(坑距 400mm)
(坑距 305-435mm) (镀铬)
CES8G320GCNP
(H=120-130mm) (镀铬)

诺锐斯特®智能全自动一体型电子坐便器
725*411*497mm
EcoMAX DUAL 3L/3.8L 大小切换

*CES8G320GCNP 冲水量 3L/4.5L

智能洁净系统

DESIGN AWARD 2022

reddot winner 2022

*所有排水连接件需另购



NEOREST. AS
CES8C510KCN
(坑距 305mm)
(坑距 400mm)
(坑距 280-435mm) (银色)
CES8C510KCNP
(H=120-155mm) (银色)
CES8E810GCN
(坑距 305mm)
(坑距 400mm)
(坑距 280-435mm) (银色)
CES8E810GCNP
(H=120-155mm) (银色)

诺锐斯特®智能全自动一体型电子坐便器
692*386*512mm
EcoMAX DUAL 3L/3.8L 大小切换

*CES8C510KCNP 冲水量 3L/4.5L

*CES8E810GCNP 冲水量 3L/4.5L

智能洁净系统

DESIGN AWARD 2022

reddot winner 2022

*所有排水连接件需另购



NEOREST. RS
CES8A510KCN
(坑距 305mm)
(坑距 400mm)
(坑距 280-435mm) (银色)
CES8A510KCNP
(H=120-155mm) (银色)

诺锐斯特®智能全自动一体型电子坐便器
690*386*515mm
EcoMAX DUAL 3L/3.8L 大小切换

*CES8A510KCNP 冲水量 3L/4.5L

智能洁净系统

reddot winner 2022

*所有排水连接件需另购



NEOREST. RS
CES8A410KCN
(坑距 305mm)
(坑距 400mm)
(坑距 280-435mm) (白色)
CES8A410KCNP
(H=120-155mm) (白色)

诺锐斯特®智能全自动一体型电子坐便器
690*386*515mm
EcoMAX DUAL 3L/3.8L 大小切换

*CES8A410KCNP 冲水量 3L/4.5L

智能洁净系统

reddot winner 2022

*所有排水连接件需另购



TOTO
WASHLET



卫洗丽®
washlet®

"WASHLET", "washlet" 和 "卫洗丽" 是 TOTO 株式会社"智能冲洗坐便盖"等的注册商标。

卫洗丽® washLÉT.®

卫洗丽® 智能一体型坐便器
 卫洗丽® 智能组合坐便器
 卫洗丽® 智能冲洗坐便盖

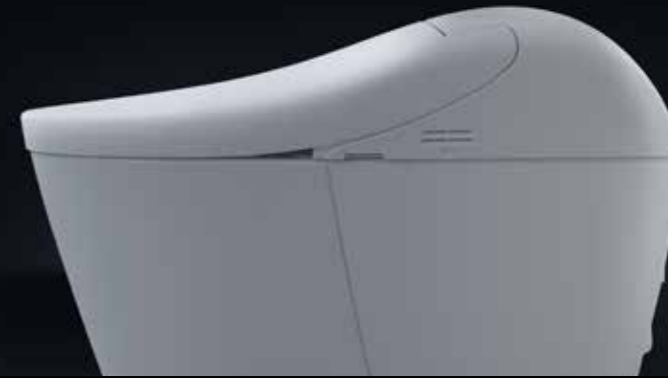

优雅的曲线，柔和的造型，与空间融为一体；简约的机能部设计，低水箱造型更为优雅；一体型设计，减少外观缝隙

智能洁净系统



便器内壁
防污喷雾技术



纳米抗污
釉面技术



空气注入式
水珠洗净技术



便盖自动开闭技术



内壁易洁
结构设计



360°漩涡式
冲洗技术



便器自动冲洗技术



便盖保温技术



喷嘴
电解水除菌技术



便器内壁
电解水除菌技术



暖风干燥技术



节水技术

- 喷嘴自清洁
- 臀部洗净
- 按摩洗净
- 自动节电

- 洁净材质
- 臀部轻柔洗净
- 摆动洗净
- 柔光照明

- 一键装卸
- 下身洗净
- 水势调节

- 除臭
- 下身护理洗净
- 洗净位置调整



推荐产品 RECOMMEND PRODUCTS



卫洗丽® G5A
CES7H311KCN
(坑距 305mm)
(坑距 400mm)
(坑距 270-400mm)

卫洗丽® 智能一体型坐便器
722*386*546mm
EcoMAX DUAL 3L/4.5L 大小切换



*所有排水连接件需另购



卫洗丽® G5N
CES7C311KCN
(坑距 305mm)
(坑距 400mm)
(坑距 270-400mm)

卫洗丽® 智能一体型坐便器
722*386*526mm
EcoMAX DUAL 3L/4.5L 大小切换



*所有排水连接件需另购



推荐产品 RECOMMEND PRODUCTS



卫洗丽® W7
CES8A2E2CS (H=220mm)

卫洗丽® 智能一体型坐便器
589*391*443mm
EcoMAX DUAL 3/4.5L 大小切换
推荐搭配:
水箱面板 MB175M
隐藏式水箱 WH173BATR



卫洗丽® W7
CES8A4E2CS (H=220mm)

卫洗丽® 智能一体型坐便器
589*391*443mm
EcoMAX DUAL 3/4.5L 大小切换
推荐搭配:
水箱面板 MB171M
隐藏式水箱 WH173BATR



强劲冲洗

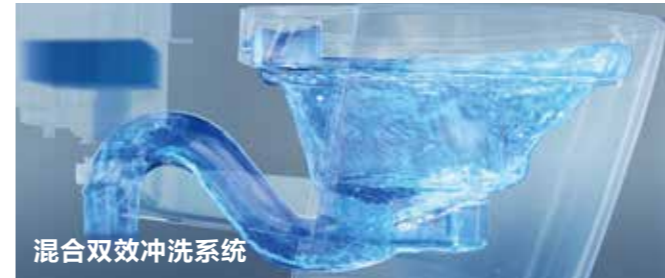

劲澈力
INTEGRALITY SYSTEM

通过水管直供水,持续产生漩涡环绕便器内壁进行清洗,同步通过水箱里水重力提供的喷射力将污物推离管道。较大的水封面,保持便器清洁。

*G5A 新品 & G5N 搭载混合双效冲洗系统

智能洁净系统

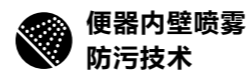

便器内壁喷雾
防污技术

污垢浮在陶瓷表面,难以粘附



360°漩涡式
冲洗技术

漩涡式强劲冲洗



内壁易洁
结构设计

让污垢、细菌难以藏身,更重要的是打扫坐便器变得更为轻松

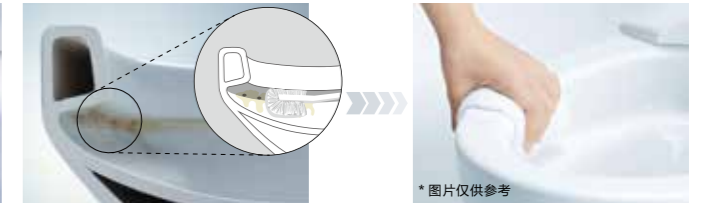

*图片仅供参考



纳米抗污
釉面技术

污垢容易冲落

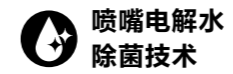

喷嘴电解水
除菌技术

去除粘附在喷嘴上的细菌

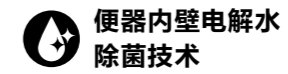

便器内壁电解水
除菌技术

去除粘附在坐便器上的细菌

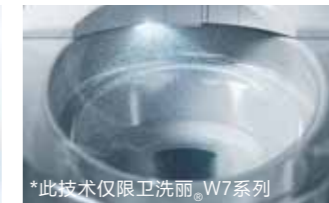

*此技术仅限卫洗丽®W7系列



更多技术详情

持久洁净

坐便盖缓冲垫无缝设计

坐便盖缓冲垫无缝设计,污物不易残留,方便清扫。



坐便盖无缝设计

坐便盖无缝设计,不易结垢,污垢可以轻松清扫。

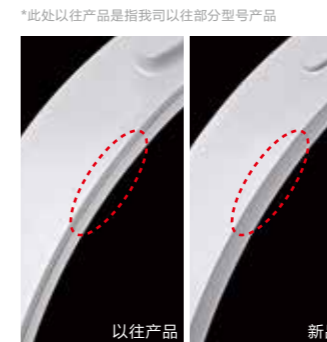

以往产品

新品

洁净材质

选用优质树脂,不但可以防止污物粘附,还能防止材质变色,更好地保持表面持久洁净。



普通材质容易挂污



洁净材质防止污物粘附



卫洗丽® G5A
CES7H311KCN
(坑距 305mm)
(坑距 400mm)
(坑距 270-400mm)

* 所有排水连接件需另购

卫洗丽® 智能一体型坐便器
722*386*546mm
EcoMAX DUAL 3L/4.5L 大小切换

智能洁净系统



卫洗丽® G5N
CES7C311KCN
(坑距 305mm)
(坑距 400mm)
(坑距 270-400mm)

* 所有排水连接件需另购

卫洗丽® 智能一体型坐便器
722*386*526mm
EcoMAX DUAL 3L/4.5L 大小切换

智能洁净系统



卫洗丽® G5B
CFS7G511KCN
(坑距 305mm)
(坑距 400mm)
(坑距 280-435mm)

* 所有排水连接件需另购

卫洗丽® 智能一体型坐便器
725*401*501mm
EcoMAX DUAL 3.3L/4.8L 大小切换

智能洁净系统

red dot winner 2026



卫洗丽® G5B
CFS7G311KCN
(坑距 305mm)
(坑距 400mm)
(坑距 280-435mm)

* 所有排水连接件需另购

卫洗丽® 智能一体型坐便器
725*401*501mm
EcoMAX DUAL 3.3L/4.8L 大小切换

智能洁净系统

red dot winner 2026



卫洗丽® W7
CES8A2E2CS
(H=220mm)

MB175M
隐藏式水箱面板

CES8B2E2CS
(H=220mm)

CES8C2E2CS
(H=220mm)

卫洗丽® 智能一体型坐便器
589*391*443mm
EcoMAX DUAL 3L/4.5L 大小切换
隐藏式水箱 WH173BATR

智能洁净系统

隐藏式水箱 WH143BAT (低水箱)

隐藏式水箱 WH173BATFF (自立式水箱)

推荐搭配:
水箱面板 MB175M



卫洗丽® W7
CES8A2ECCS
(H=220mm)

MB175M
隐藏式水箱面板

NEW

卫洗丽® 智能一体型坐便器
589*391*435mm
EcoMAX DUAL 3L/4.5L 大小切换
隐藏式水箱 WH173BATR

智能洁净系统

推荐搭配:
水箱面板 MB175M



卫洗丽® W7
CES8A2EBCS
(H=220mm)

MB175M
隐藏式水箱面板

NEW

卫洗丽® 智能一体型坐便器
589*391*481mm
EcoMAX DUAL 3L/4.5L 大小切换
隐藏式水箱 WH173BATR

智能洁净系统

推荐搭配:
水箱面板 MB175M



卫洗丽® W7
CES8A4E2CS
(H=220mm)

MB171M
隐藏式水箱面板

CES8B4E2CS
(H=220mm)

CES8C4E2CS
(H=220mm)

卫洗丽® 智能一体型坐便器
589*391*443mm
EcoMAX DUAL 3L/4.5L 大小切换
隐藏式水箱 WH173BATR

智能洁净系统

隐藏式水箱 WH143BAT (低水箱)

隐藏式水箱 WH173BATFF (自立式水箱)

推荐搭配:
水箱面板 MB171M



卫洗丽® W5
CES7A5CS
(H=220mm)

MB175M
隐藏式水箱面板

CES7B5CS
(H=220mm)

CES7C5CS
(H=220mm)

卫洗丽® 智能一体型坐便器
589*391*481mm
EcoMAX DUAL 3L/4.5L 大小切换
隐藏式水箱 WH173BATR

智能洁净系统

隐藏式水箱 WH143BAT (低水箱)

隐藏式水箱 WH173BATFF (自立式水箱)

推荐搭配:
水箱面板 MB175M



卫洗丽® W5
CES7A7CS
(H=220mm)

MB171M
隐藏式水箱面板

CES7B7CS
(H=220mm)

CES7C7CS
(H=220mm)

卫洗丽® 智能一体型坐便器
589*386*481mm
EcoMAX DUAL 3L/4.5L 大小切换
隐藏式水箱 WH173BATR

智能洁净系统

隐藏式水箱 WH143BAT (低水箱)

隐藏式水箱 WH173BATFF (自立式水箱)

推荐搭配:
水箱面板 MB171M

推荐组合 RECOMMEND PRODUCTS



CW923SEBT305
CW923SEBT400
推荐搭配：卫洗丽® S7 TCF4E360KCN

卫洗丽® 智能组合坐便器
720*510*665mm
EcoMAX 4.6L 节水

智能洁净系统

可以选装自动冲洗功能



CW988SEBT305
CW988SEBT400
推荐搭配：卫洗丽® S5 TCF3G460KCN

卫洗丽® 智能组合坐便器
715*450*678mm
EcoMAX 4.6L 节水
推荐搭配：自动冲洗套件 TCA432

智能洁净系统

可以选装自动冲洗功能



CW767EB/SW767BT305
CW767EB/SW767BT400
推荐搭配：卫洗丽® S2 TCF3A260KCN

卫洗丽® 智能组合坐便器
727*445*698mm
EcoMAX 4.6L 节水

智能洁净系统



CW822EB
推荐搭配：卫洗丽® S2 TCF3A460KCN

卫洗丽® 智能组合坐便器
540*380*460mm
EcoMAX DUAL 3/4.5L 大小切换

智能洁净系统



CW982EBT305/SW982EBT305
CW982EBT400/SW982EBT400
推荐搭配：卫洗丽® C2 TCF2A960KCN

卫洗丽® 智能组合坐便器
700*395*766mm
EcoMAX DUAL 3/4.5L 大小切换

智能洁净系统



CW830EB/SW830EB
(坑距 305mm)
(坑距 400mm)
推荐搭配：卫洗丽® S2 TCF3A260KCN

卫洗丽® 智能组合坐便器
700*394*729mm
EcoMAX 4.6L 节水

智能洁净系统

*所有排水连接件需另购

水电隐藏

外形美观的坐便器与卫洗丽® 的贴心组合。



由卫洗丽® 与坐便器组合在一起的新系列，独特设计、别出心裁。此构造为 TOTO 精心设计，将其卫洗丽® 的供水软管和电源线隐藏在坐便器内侧。



坐便器与卫洗丽® 之间几乎不留空隙，力求二者在外观上完美结合。

简洁流畅的坐便器形状，便于适合多种空间。

便盖的形状与坐便的边缘线吻合一致。精炼的设计风格为您渲染出舒心的生活空间。

智能洁净系统

便器内壁喷雾防污技术

污垢浮在陶瓷表面，难以粘附

纳米抗污釉面技术

污垢容易冲落

360°漩涡式冲洗技术

漩涡式强劲冲洗

便器内壁电解水除菌技术

去除粘附在坐便器上的细菌

喷嘴电解水除菌技术

去除粘附在喷嘴上的细菌



持久洁净

内壁易洁结构设计

让污垢、细菌难以藏身，更重要的是打扫坐便器变得更为轻松。



以往便器内壁的出水小孔设计使污垢容易堆积，长时间使用后易形成黄斑，难以祛除。

*此处以往产品是指我可以往部分型号产品



便器内壁可见，一眼就能确认污垢，打扫无死角。

洁净材质

选用优质树脂，不但可以防止污物粘附，还能防止材质变色，保持表面持久洁净。



普通材质容易挂污

洁净材质防止污物粘附



更多技术详情

智能推荐组合

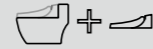

可搭配便盖



CW636REAB
推荐搭配：卫洗丽® S7 TCF4E960KCN

卫洗丽® 智能组合坐便器
740*488*670mm
EcoMAX DUAL 3/4.5L 大小切换



选装自动冲洗功能需选购 CW636REAB, CW636REB 不支持追加



CW923SEBT305
CW923SEBT400
推荐搭配：卫洗丽® S7 TCF4E360KCN

卫洗丽® 智能组合坐便器
720*510*665mm
EcoMAX 4.6L 节水



可以选装自动冲洗功能



CW988SEBT305
CW988SEBT400
推荐搭配：卫洗丽® S5 TCF3G460KCN

卫洗丽® 智能组合坐便器
715*450*678mm
EcoMAX 4.6L 节水



可以选装自动冲洗功能



卫洗丽® S7

TCF4E360KCN
TCF4E960KCN

可以选装自动冲洗功能

卫洗丽® 智能冲洗坐便盖
532*383*125mm



卫洗丽® S5

TCF3G460KCN

可以选装自动冲洗功能

卫洗丽® 智能冲洗坐便盖
532*382*131mm



卫洗丽® S2

TCF3A460KCN
TCF3A260KCN

卫洗丽® 智能冲洗坐便盖
532*462*131mm



智能推荐组合

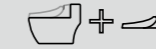

可搭配便盖



CW188SEBT305
CW188SEBT400
推荐搭配：卫洗丽® S5 TCF3G460KCN

卫洗丽® 智能组合坐便器
722*420*655mm
EcoMAX 3.8L 超级节水



可以选装自动冲洗功能



CW887REBT305
CW887REBT400
推荐搭配：卫洗丽® S2 TCF3A260KCN

卫洗丽® 智能组合坐便器
727*428*657mm
EcoMAX 4.6L 节水



可以选装自动冲洗功能



CW987SEBT305
CW987SEBT400
推荐搭配：卫洗丽® S2 TCF3A460KCN

卫洗丽® 智能组合坐便器
701*387*699mm
EcoMAX DUAL 3/4.5L 大小切换



卫洗丽® S7

TCF4E360KCN
TCF4E960KCN

可以选装自动冲洗功能

卫洗丽® 智能冲洗坐便盖
532*383*125mm



卫洗丽® S5

TCF3G460KCN

可以选装自动冲洗功能

卫洗丽® 智能冲洗坐便盖
532*382*131mm



卫洗丽® S2

TCF3A460KCN
TCF3A260KCN

卫洗丽® 智能冲洗坐便盖
532*462*131mm



卫洗丽® C2

TCF2A960KCN

卫洗丽® 智能冲洗坐便盖
531*473*168mm



智能推荐组合

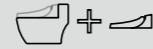

可搭配便盖



CW788REBT305/SW788REBT305
CW788REBT400/SW788REBT400
推荐搭配：卫洗丽® S2 TCF3A460KCN

卫洗丽® 智能组合坐便器
722*420*721mm
EcoMAX 3.8L 超级节水



CW767EBT305/SW767BT305
CW767EBT400/SW767BT400
推荐搭配：卫洗丽® S2 TCF3A260KCN

卫洗丽® 智能组合坐便器
727*445*698mm
EcoMAX 4.6L 节水



CW982EBT305/SW982EBT305
CW982EBT400/SW982EBT400
推荐搭配：卫洗丽® C2 TCF2A960KCN

卫洗丽® 智能组合坐便器
700*395*766mm
EcoMAX DUAL 3/4.5L 大小切换



卫洗丽® S7

TCF4E360KCN
TCF4E960KCN

可以选装自动冲洗功能

卫洗丽® 智能冲洗坐便盖
532*383*125mm



卫洗丽® S5

TCF3G460KCN

可以选装自动冲洗功能

卫洗丽® 智能冲洗坐便盖
532*382*131mm



卫洗丽® S2

TCF3A460KCN
TCF3A260KCN

卫洗丽® 智能冲洗坐便盖
532*462*131mm



智能推荐组合

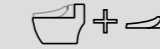

可搭配便盖



MB174P
隐藏式水箱面板

CW822EB
推荐搭配：卫洗丽® S7 TCF4E360KCN

卫洗丽® 智能组合坐便器
540*380*335mm
EcoMAX DUAL 3/4.5L 大小切换



MB174P
隐藏式水箱面板

CW582EB
推荐搭配：卫洗丽® S5 TCF3G460KCN

卫洗丽® 智能组合坐便器
540*380*340mm
EcoMAX DUAL 3/4.5L 大小切换



卫洗丽® S7

TCF4E360KCN
TCF4E960KCN

可以选装自动冲洗功能

卫洗丽® 智能冲洗坐便盖
532*383*125mm



卫洗丽® S5

TCF3G460KCN

可以选装自动冲洗功能

卫洗丽® 智能冲洗坐便盖
532*382*131mm



卫洗丽® S2

TCF3A460KCN
TCF3A260KCN

卫洗丽® 智能冲洗坐便盖
532*462*131mm



卫洗丽® C2

TCF2A960KCN

卫洗丽® 智能冲洗坐便盖
531*473*168mm



个性搭配



根据安装条件及个人喜好，选择其他可供搭配的卫洗丽产品

washLÉT.
+
TOILET



外形美观的坐便器与卫洗丽®的贴心组合。

卫洗丽® 智能组合坐便器搭配表

| 便器品番 | 智能冲洗坐便盖品番 | 卫洗丽® S7 系列 | 卫洗丽® S7 系列 | 卫洗丽® S5 系列 | 卫洗丽® S5系列(D型) | 卫洗丽® S2 系列 | 卫洗丽® S2系列(D型) | 卫洗丽® C2 系列 |
|-------------------|-----------|-------------|-------------|-------------|---------------|----------------------------|---------------|-------------|
| | | TCF4E960KCN | TCF4E360KCN | TCF3G460KCN | TCF34570GCN | TCF3A460KCN TCF3A260KCN | TCF33370GCN | TCF2A960KCN |
| 自动冲洗单元型号 | | 已和便器同捆 | 支持选购 | 支持选购 | 支持选购 | 不支持选购 | 不支持选购 | 不支持选购 |
| CW636REAB | | ◎ | | | | | | |
| CW636REB | | | ○ | ○ | | ○ | | |
| CW923SEB | TCA517 | | ◎ | ◎ | | ○ | | |
| CW988SEB | TCA517 | | ◎ | ◎ | | ○ | | |
| CW188SEB | TCA516 | | ◎ | ◎ | | ○ | | ○ |
| CW887REB | TCA517 | | ◎ | ◎ | | ○ | | ○ |
| CW987SEB | TCA515 | | ◎ | ◎ | | ○ | | ○ |
| CW788REB/SW788REB | TCA516 | | ◎ | ◎ | | ○ | | ○ |
| CW767EB/SW767EB | TCA517 | | ◎ | ◎ | | ○ | | ○ |
| CW982EB/SW982EB | TCA515 | | ◎ | ◎ | | ○ | | ○ |
| CW982PEB/CW982PEB | TCA515 | | ◎ | ◎ | | ○ | | ○ |
| CW830EB/SW830EB | TCA517 | | ◎ | ◎ | | ○ | | ○ |
| CW822EB | TCA518 | | ◎ | ◎ | | ○ | | ○ |
| CW582EB | TCA518 | | ◎ | ◎ | | ○ | | ○ |
| CW553EB | TCA518 | | | | ◎ | | ○ | |

○ 卫洗丽®智能冲洗坐便盖与便器可以适配组合为卫洗丽®智能组合坐便器。（壁挂式坐便器需要选购对应的隐藏式水箱WH173BTR、WH143BT、WH173BTFF以及安装组件TCA463。）

◎ 该搭配可以支持选购自动冲洗套件。（壁挂式坐便器的自动冲洗功能需要同时选购对应的隐藏式水箱WH173BATR、WH143BAT、WH173BATFF。）

内外如一的洁净

喷嘴电解水除菌技术



每次冲洗前喷嘴都会进行“自动清洁”
冲洗结束时喷嘴会自行清洁
电解除菌水还会对喷嘴内部、外部进行清洁除菌
即使长时间不使用，也会定时进行清洁，保持坐便器干净卫生

便器内壁电解水除菌技术

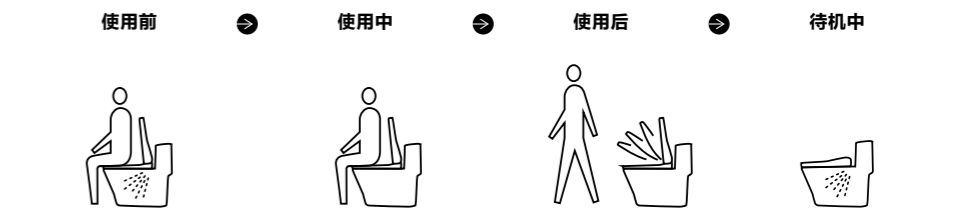

洁净喷雾：雾状的普通生活用水喷洒于坐便器表面
坐便器表面被水雾覆盖后，污垢难以粘附，冲洗更容易
电解除菌水对喷嘴和坐便器表面进行清洁、除菌
如果坐便器八个小时没有使用，会自动喷射出雾状的电解除菌水，以防止细菌繁殖

什么是电解除菌水？

普通生活用水经过电解后形成电解水，电解水所含的次氯酸成分，具有除菌作用。整个过程不添加化学药品和清洗剂。一定时间后，电解除菌水会自动还原成普通水，自然、环保。

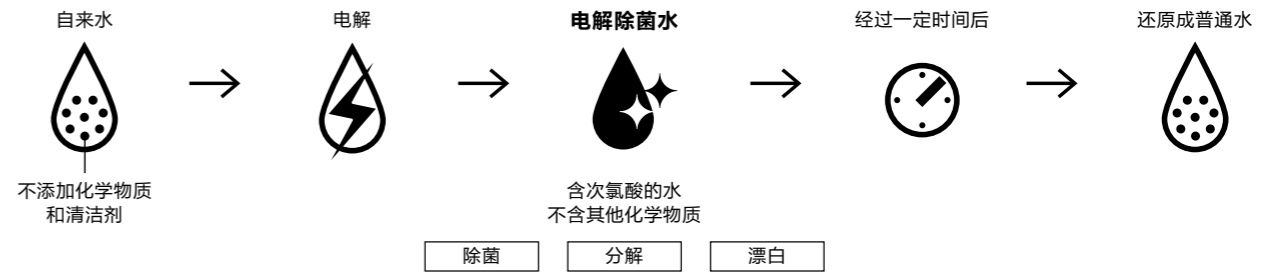

污物不易残留

便器内壁防污喷雾技术

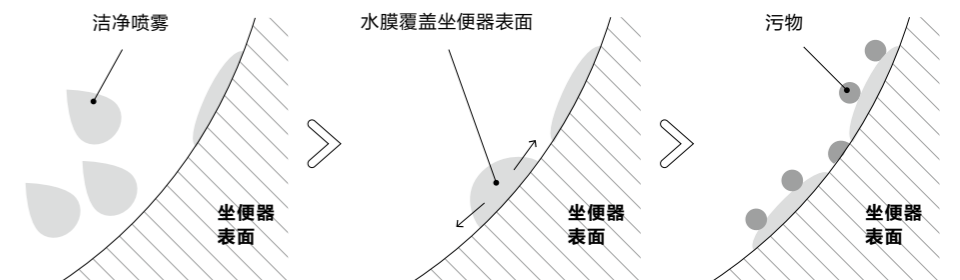
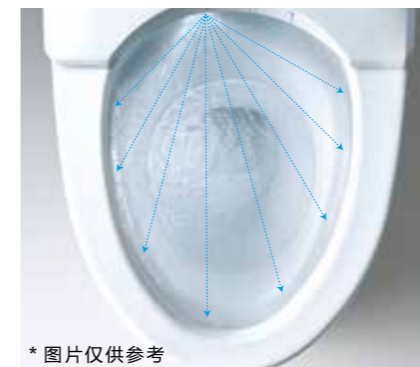

每次使用前，都会喷洒水雾。利用陶瓷亲水性，使污物更易清洗干净。

* 图片仅供参考



| | | | |
|---|---------------------------------------|-------------------------------|--|
|  | 卫洗丽® S7 TCF4E360KCN TCF4E960KCN | 卫洗丽® 智能冲洗坐便盖 530*383*103mm | 智能洁净系统  |
| | | | |

| | | | |
|---|------------------------|-------------------------------|--|
|  | 卫洗丽® S5 TCF3G460KCN | 卫洗丽® 智能冲洗坐便盖 532*381*131mm | 智能洁净系统  |
| | | | |

| | | | |
|---|------------------------|--|---|
|  | 卫洗丽® S2 TCF3A460KCN | 卫洗丽® 智能冲洗坐便盖 532*462*131mm | 智能洁净系统  |
| | TCF3A260KCN | 卫洗丽® 智能冲洗坐便盖 532*462*131mm (无喷嘴除菌) | |



| | | | |
|---|------------------------|-------------------------------|---|
|  | 卫洗丽® C2 TCF2A960KCN | 卫洗丽® 智能冲洗坐便盖 531*473*168mm |  |
| | TCF2A910KCN | 卫洗丽® 智能冲洗坐便盖 531*473*168mm | |



| | | | |
|---|----------------------------|--|--|
|  | 卫洗丽® S5(D型) TCF34570GCN | 卫洗丽® 智能冲洗坐便盖 (D型) 540*383*130mm | 智能洁净系统  |
| | TCF34320GCN | 卫洗丽® 智能冲洗坐便盖 (D型) 540*383*130mm (无遥控器冲洗, 自动便器冲洗) | |

| | | | |
|---|-----------------------------|------------------------------------|--|
|  | 卫洗丽® S2 (D型) TCF33370GCN | 卫洗丽® 智能冲洗坐便盖 (D型) 540*462*130mm | 智能洁净系统  |
| | TCF33320GCN | 卫洗丽® 智能冲洗坐便盖 (D型) 540*462*130mm | |

| | | | |
|---|--------------------|--|--------|
|  | YEW350 V3 (进口品) | 便携式洁身器 67*46*130mm (使用时 67*46*298mm) | 便携式洁身器 |
|---|--------------------|--|--------|

便携式洁身器

| 系列 | | 卫洗丽® S7 系列 | 卫洗丽® S5 系列 | 卫洗丽® S5 系列 | |
|--------|----------------|---|--|---|--|
| 外观 | |  |  |  | |
| 品番 | | TCF4F360MCN | TCF3H360MCN | TCF34570GCN TCF34320GCN | |
| 控制方式 | | 遥控器 | 遥控器 | 遥控器 | |
| 基本功能 | 洗净方式 | 臀部洗净 | ○ | ○ | ○ |
| | | 臀部轻柔洗净 | ○ | × | ○ |
| | | 下身洗净 | ○ | ○ | ○ |
| | | 下身护理洗净 | ○ | × | × |
| | 改变洗净方式 | 洗净位置调节 | ○ | ○ | ○ |
| | | 摆动洗净 | ○ | ○ | ○ |
| | | 按摩洗净 | ○ | × | ○ |
| | | 个性设定 | ○ | ○ | ○ |
| 清洁功能 | 干燥 | 暖风干燥技术 | ○ | ○ | ○ |
| | 祛除异味 | 除臭技术 | ○ | ○ | ○ |
| | 用干净的除菌水保持清洁状态 | 喷嘴电解水除菌技术 | ○ | ○ | ○ |
| | | 便器内壁电解水除菌技术 | ○ | × | × |
| | 使污垢不易附着 | 便器内壁喷雾防污技术 | ○ | ○ | ○ |
| 便利功能 | 冲水 | 自动便器冲洗 | ○ 壁挂式坐便器需搭配WH173BAT 系列 | ○ 壁挂式坐便器需搭配WH173BAT 系列 | ○ (限 TCF34570GCN) 壁挂式坐便器需搭配WH173BAT 系列 |
| | | 用遥控器冲洗便器 | ○ 壁挂式坐便器需搭配WH173BAT 系列 | ○ 壁挂式坐便器需搭配WH173BAT 系列 | ○ (限 TCF34570GCN) 壁挂式坐便器需搭配WH173BAT 系列 |
| | 打开或关闭 | 遥控开 / 关便座 | ○ | × | × |
| | | 自动便盖开闭 | ○ | × | × |
| | 照明灯 | 柔和照明 | ○ | × | × |
| | 便座加热 | 便盖保温技术 | ○ | ○ | ○ |
| | 降低便座的温度进行节电的方法 | 自动节电 | ○ | ○ | ○ |
| | | 定时节电 | ○ | ○ | ○ |
| 超级自动节电 | | ○ | × | ○ | |
| 维修保养 | 本体一体式装卸 | ○ | ○ | ○ | |
| | 喷嘴清扫 | ○ | ○ | ○ | |
| | 洁净材质 | ○ | ○ | ○ | |
| | 无缝便圈 | ○ | ○ | ○ | |

| 卫洗丽® S2 系列 | 卫洗丽® S2 系列 | 卫洗丽® C2 系列 |
|---|---|---|
|  |  |  |
| TCF33370GCN TCF33320GCN | TCF3B360MCN TCF3B160MCN | TCF2B960MCN TCF2B910MCN TCF2B710MCN |
| 袖部控制器 | 袖部控制器 | 袖部控制器 |
| ○ | ○ | ○ |
| ○ | × | × |
| ○ | ○ | ○ |
| × | × | × |
| ○ | ○ | ○ |
| ○ | ○ | ○ |
| ○ | × | × |
| × | × | × |
| ○ | ○ | ○ (限 TCF2B960MCN, TCF2B910MCN) |
| ○ | ○ | ○ (限 TCF2B960MCN, TCF2B910MCN) |
| ○ | ○ (限 TCF3B360MCN) | × |
| × | × | × |
| ○ | ○ | ○ |
| × | × | × |
| × | × | × |
| ○ | ○ | ○ |
| ○ | ○ | ○ |
| ○ | × | × |
| ○ | ○ | ○ |
| ○ | ○ | ○ |
| ○ | ○ | ○ |
| ○ | ○ | × |

智能一体型坐便器

轻智能版

Smart Toilet Lite



智能洁净系统



360°漩涡式
冲洗技术



纳米抗污
釉面技术



便盖自动开闭技术



内壁易洁
结构设计



坐便盖缓冲垫
无缝设计



便器自动冲洗技术



智能一体型坐便器轻智能版 G5B
CFS7A311KCN
(坑距 305mm)
(坑距 400mm)
(坑距 280-435mm)

NEW

* 所有排水连接件需另购

智能一体型坐便器 轻智能版
725*401*501mm
EcoMAX DUAL 3.3L/4.8L 大小切换

智能洁净系统



reddot winner 2026



智能一体型坐便器轻智能版 G5B
CFS7A111KCN
(坑距 305mm)
(坑距 400mm)
(坑距 280-435mm)

NEW

* 所有排水连接件需另购

智能一体型坐便器 轻智能版
725*401*501mm
EcoMAX DUAL 3.3L/4.8L 大小切换

智能洁净系统



reddot winner 2026



TOILET

冲洗高效更节水

360°漩涡式冲洗技术



强力冲洗，有效清除易残留污物

坐便器出水口释放出旋转式的动态水流，沿无棱内壁回旋数周，以恒势水压清除最易积累污物的区域，再将这个内壁冲洗干净。优质陶瓷让这项创新设计变成可能。

内壁易洁结构设计

内壁易洁结构设计



特别的无棱内壁设计，让污垢、细菌难以藏身，更重要的是打扫坐便器变得更为轻松。

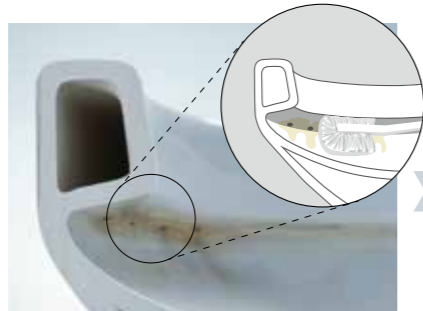

以往便器内壁的出水小孔设计使污垢容易堆积，长时间使用后会形成黄斑，难以祛除。

*此处以往便器是指我可以往部分型号产品



* 图片仅供参考

便器内壁可见，一眼就能确认污垢，打扫无死角。

持久洁净，经久耐用

纳米抗污釉面技术



冲洗时坐便器表面的断面放大示意图



疏水

亲水

减少容易藏污纳垢的陶瓷表面凹凸

普通陶瓷釉面看上去也许非常光滑，但其实存在肉眼看不见的凹凸、污垢、霉菌、细菌容易藏身其中。采用纳米抗污釉面技术的坐便器内壁，釉面空隙小到纳米水平，几乎不给污垢容身空间。

智洁坐便器拥有良好的亲水性

亲水性这个词语经常被用来表达材料与水良好交融的状态。智洁坐便器正是这样一种具有亲水性的产品。冲洗坐便器时，水流迅速覆盖坐便器内壁，冲洗污垢更加轻松。



CW636REB (坑距 305mm)

连体式坐便器
740*490*670mm
EcoMAX DUAL 3/4.5L 大小切换



CW923SEBT305 (坑距 305mm)
CW923SEBT400 (坑距 400mm)

连体式坐便器
720*510*665mm
EcoMAX 4.6L 节水



CW988SEBT305 (坑距 305mm)
CW988SEBT400 (坑距 400mm)

连体式坐便器
715*450*678mm
EcoMAX 4.6L 节水



CW188SEBT305 (坑距 305mm)
CW188SEBT400 (坑距 400mm)

连体式坐便器
722*420*655mm
EcoMAX 3.8L 超级节水



CW887REBT305 (坑距 305mm)
CW887REBT400 (坑距 400mm)

连体式坐便器
727*428*657mm
EcoMAX 4.6L 节水



CW987SEBT305 (坑距 305mm)
CW987SEBT400 (坑距 400mm)

连体式坐便器
701*387*699mm
EcoMAX DUAL 3/4.5L 大小切换



CW166SPB (H=180mm)

连体式坐便器
704*392*697mm
EcoMAX DUAL 3/4.5L 大小切换





CW788REBT305/SW788REBT305
(坑距 305mm)
CW788REBT400/SW788REBT400
(坑距 400mm)

分体式坐便器
722*420*721mm
EcoMAX 3.8L 超级节水



CW982EBT305/SW984EBT305
(坑距 305mm)
CW982EBT400/SW984EBT400
(坑距 400mm)

分体式坐便器
700*483*764mm
EcoMAX DUAL 3/4.5L 大小切换



CW767EBT305/SW767BT305
(坑距 305mm)
CW767EBT400/SW767BT400
(坑距 400mm)

分体式坐便器
727*445*698mm
EcoMAX 4.6L 节水



CW982EBT305/SW982EBT305
(坑距 305mm)
CW982EBT400/SW982EBT400
(坑距 400mm)

分体式坐便器
700*395*747mm
EcoMAX DUAL 3/4.5L 大小切换



CW982PEB/SW982PEB
(H=180mm)

分体式坐便器
700*395*732mm
EcoMAX DUAL 3/4.5L 大小切换



CW830EB/SW830EB
(坑距 305mm)
(坑距 400mm)

分体式坐便器
700*395*729mm
EcoMAX 4.6L 节水

排水连接件另购



CW781RPB/SW781SPB
(H=180mm)

分体式坐便器
700*376*765mm
EcoMAX DUAL 3/4.5L 大小切换



CW542B (H=220mm)

壁挂式隐藏水箱坐便器
580*380*335mm
EcoMAX DUAL 3/4.5L 大小切换
推荐搭配:
隐藏式水箱
WH143BT-542B/WH173B-542B/
WH173BTFF-542B
水箱面板 MB175M



CW522B (H=220mm)

壁挂式隐藏水箱坐便器
580*380*335mm
EcoMAX DUAL 3/4.5L 大小切换
推荐搭配:
隐藏式水箱
WH143BT-522B/WH173B-522B/
WH173BTFF-522B
水箱面板 MB171M



CW822EB (H=220mm)

壁挂式隐藏水箱坐便器
540*380*335mm
EcoMAX DUAL 3/4.5L 大小切换
推荐搭配: 卫洗丽® TCF4E360KCN
隐藏式水箱
WH143B-822EB
WH173BTFF-822EB
WH173BTR-822EB+TCA463 (安装组件)
WH173BTR-822EB+TCA463 (自动冲洗组件)
WH143BT-822EB+TCA463 (安装组件)
WH143BAT-822EB+TCA518 (自动冲洗组件)
WH173BTFF-822EB+TCA463 (安装组件)
WH173BATFF-822EB+TCA518 (自动冲洗组件)
水箱面板 MB174P



CW553B (H=220mm)
CW553EB (H=220mm)

壁挂式隐藏水箱坐便器
540*380*335mm
EcoMAX DUAL 3.0/4.5L 大小切换
推荐搭配:
卫洗丽® TCF34570GCN (搭配 CW553REB)
隐藏式水箱
WH143B-553B
WH173BTFF-553B
WH173BTR-553EB+TCA463 (安装组件)
WH173BTR-553EB+TCA518 (自动冲洗组件)
WH143BT-553B+TCA463 (安装组件)
WH143BAT-553EB+TCA518 (自动冲洗组件)
WH173BTFF-553B+TCA463 (安装组件)
WH173BATFF-553EB+TCA518 (自动冲洗组件)
水箱面板 MB170P/MB171M



CW582EB (H=220mm)

壁挂式隐藏水箱坐便器
540*380*340mm
EcoMAX DUAL 3/4.5L 大小切换
推荐搭配:
卫洗丽® TCF3G460KCN
隐藏式水箱
WH143B-582EB
WH173BTFF-582EB
WH173BTR-582EB+TCA463 (安装组件)
WH143BT-582EB+TCA463 (安装组件)
WH173BTFF-582EB+TCA463 (安装组件)
水箱面板 MB174P



CW763B (坑距 200mm)
CW763PB (H=180mm)

落地式隐藏水箱坐便器
630*380*483mm
EcoMAX DUAL 3.3/4.8L 大小切换
推荐搭配:
卫洗丽® TCF33320GCN
隐藏式水箱
WH172BNF-763B/WH172BNF-763PB
水箱面板 MB170P/MB174P/MB176G



| | | |
|--|---------------|--------------------------------|
|  | MB177M#N (镀镍) | 手动隐藏式水箱工作面板 235*25.25*152mm |
| | MB177M#S (银色) | 手动隐藏式水箱工作面板 235*25.25*152mm |

| | | |
|--|-------------|--------------------------------|
|  | MB008W (白色) | 自动感应隐藏式水箱工作面板 238*101*154mm |
| | MB008B (黑色) | |

| | | |
|--|---------------|-----------------------------|
|  | MB176G (白色哑光) | 手动隐藏式水箱工作面板 242*32*160mm |
|--|---------------|-----------------------------|

| | | |
|---|----------------|-------------------------------|
|  | MB175M (不锈钢拉丝) | 手动隐藏式水箱工作面板 243*31.3*159mm |
|---|----------------|-------------------------------|





| | | |
|---|----------------|-------------------------------|
|  | MB171M (不锈钢拉丝) | 手动隐藏式水箱工作面板 243*31.3*159mm |
|---|----------------|-------------------------------|

| | | |
|---|------------------|-----------------------------|
|  | MB174P#WH (白色哑光) | 手动隐藏式水箱工作面板 243*30*159mm |
| | MB174P#SS (银色哑光) | 手动隐藏式水箱工作面板 243*30*159mm |

































| | | |
|---|------------------|-----------------------------|
|  | MB170P#WH (白色哑光) | 手动隐藏式水箱工作面板 243*30*159mm |
| | MB170P#SS (银色哑光) | 手动隐藏式水箱工作面板 243*30*159mm |

| | | |
|---|-------------------|-------------------------------|
|  | MB003CPR-2 (亮光电镀) | 手动隐藏式水箱工作面板 242.5*35*157mm |
|---|-------------------|-------------------------------|

| | | | |
|---|--|--|---|
|  | WH175BAT | 自动感应隐藏式水箱 冲水量: 3.0L/4.5L 大小切换 | Ⓢ |
|  | WH173BATR | 自动感应隐藏式水箱 冲水量: 3.0L/4.5L 大小切换 适用厚度 135-220mm 适用厚度 102-120mm(需另购安装配件 HP516T) | Ⓢ |
|  | WH143BAT | 自动感应隐藏式水箱 冲水量: 3.0L/4.5L 大小切换 | Ⓢ |
|  | WH173BATFF | 自动感应隐藏式水箱 冲水量: 3.0L/4.5L 大小切换 | Ⓢ |
|  | WH173BTR-822EB WH173BTR-553EB WH173BTR-582EB WH173BTR-542B WH173BTR-522B | 手动隐藏式水箱 冲水量: 3.0L/4.5L 大小切换 适用厚度 135-220mm 适用厚度 102-120mm(需另购安装配件 HP516T) | Ⓢ |
|  | WH173BATR-822EB WH173BATR-553EB | 自动感应隐藏式水箱 冲水量: 3.0L/4.5L 大小切换 适用厚度 135-220mm 适用厚度 102-120mm(需另购安装配件 HP516T) | Ⓢ |
|  | WH090R-763B WH090R-763PB | 自动感应隐藏式水箱 冲水量: 3.3L/4.8L 大小切换 | Ⓢ |
|  | WH172BNF-763B WH172BNF-763PB | 手动隐藏式水箱 冲水量: 3.3L/4.8L 大小切换 | Ⓢ |

| | | | |
|--|---|----------------------------------|---|
|  | WH143BT-553EB WH143BT-822EB WH143BT-582EB WH143BT-542B WH143BT-522B WH143BT-553B | 手动隐藏式水箱 冲水量: 3.0L/4.5L 大小切换 | Ⓢ |
|  | WH143BAT-553EB WH143BAT-822EB | 自动感应隐藏式水箱 冲水量: 3.0L/4.5L 大小切换 | Ⓢ |
|  | WH173BTFF-542B WH173BTFF-522B WH173BTFF-553B WH173BTFF-582EB WH173BTFF-822EB WH173BTFF-553EB | 手动隐藏式水箱 冲水量: 3.0L/4.5L 大小切换 | Ⓢ |
|  | WH173BATFF-822E WH173BATFF-553EB | 自动感应隐藏式水箱 冲水量: 3.0L/4.5L 大小切换 | Ⓢ |

TOTO隱藏式水箱面板坐便器搭配表

| 搭配面板 | 隱藏式水箱 | 搭配坐便器 |
|--|--|--|
|  MB177M#N MB177M#S |  WH175BAT |  CES9E480GCN CES9E380GCN |
|  MB008W MB008B |  WH090R 系列 |  CW763B/PB |
|  MB175M |  WH143BT 系列 |  CW542B CW522B CW553B CW822EB CW582EB CW553EB |
|  MB171M |  WH143BAT 系列 |  CW822EB CW553EB |
|  MB176G |  WH143BAT |  CES7B5CS CES7B7CS CES8B2E2CS CES8B4E2CS |
|  MB174P#WH |  WH173BTR 系列 |  CW822EB CW582EB CW553EB |
|  MB174P#SS |  WH173BATR |  CES7A5CS CES7A7CS CES8A2E2CS CES8A4E2CS |
|  MB170P#WH |  WH173BTFF 系列 |  CW542B CW522B CW553B CW822EB CW582EB CW553EB |
|  MB170P#SS |  WH173BATFF 系列 |  CW822EB CW553EB |
|  MB003CPR |  WH173BATFF |  CES7C5CS CES7C7CS CES8C2E2CS CES8C4E2CS |
| |  WH172BN 系列 |  CW763B/PB |

BATHROOM CABINET



陶瓷一体型台盆柜



陶瓷一体型台盆柜



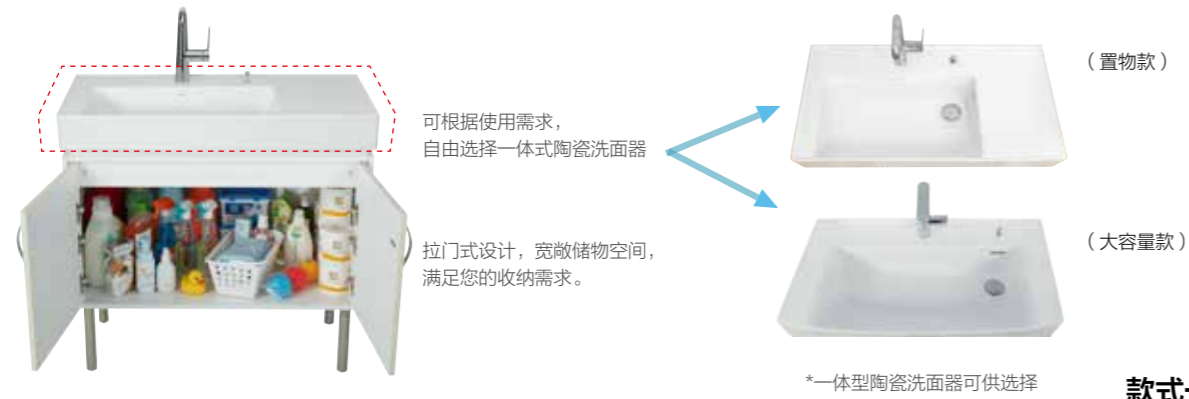

*一体式陶瓷洗面器可供选择 **款式一览表**

| 安装方式 | LBDA 型号系列 (拉门款) | 尺寸 | 颜色 |
|------|--|------------|------|
| 挂墙式 | LBDA***KL 奶茶色 LBDA***KC 摩卡色 | 长度: 600mm | 奶茶色 |
| | | 长度: 800mm | 摩卡色 |
| | | 长度: 900mm | 浅木纹色 |
| | | 长度: 1000mm | 深木纹色 |
| | LBDA***MW 浅木纹色 LBDA***MD 深木纹色 | | |

| | | | |
|-----|--|---|----------------------------|
| 落地式 | LBDA***KL 奶茶色 搭配支脚 DZ707 香槟色 | 长度: 600mm 长度: 800mm 长度: 900mm 长度: 1000mm | 奶茶色 摩卡色 浅木纹色 深木纹色 |
| | LBDA***KC 摩卡色 搭配支脚 DZ706 黑色 | | |
| | LBDA***MW 浅木纹色 搭配支脚 DZ707 香槟色 | | |
| | LBDA***MD 深木纹色 搭配支脚 DZ706 黑色 | | |

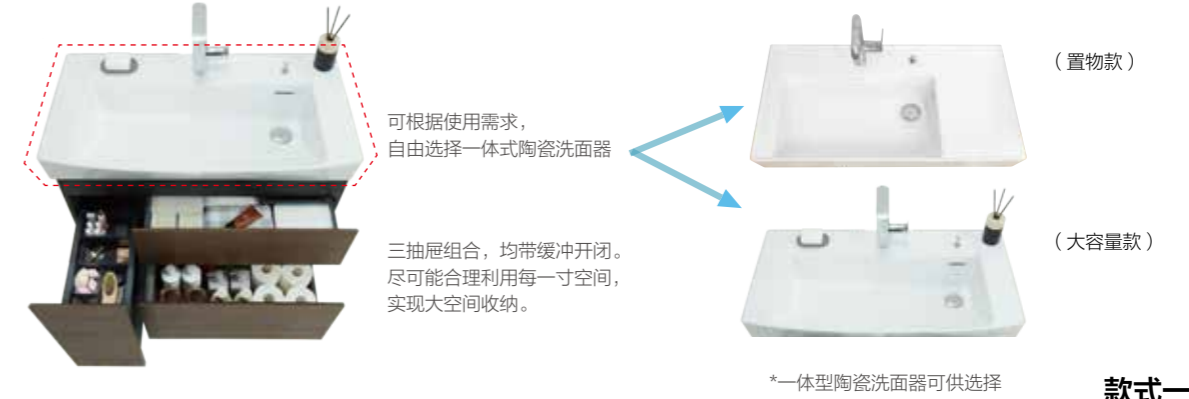

*一体式陶瓷洗面器可供选择 **款式一览表**

| 安装方式 | LBEA 型号系列 (抽屉款) | 尺寸 | 颜色 |
|------|--|------------|------|
| 挂墙式 | LBEA***RKL 奶茶色 LBEA***RKC 摩卡色 | 长度: 600mm | 奶茶色 |
| | | 长度: 800mm | 摩卡色 |
| | | 长度: 900mm | 浅木纹色 |
| | | 长度: 1000mm | 深木纹色 |
| | LBEA***RMW 浅木纹色 LBEA***RMD 深木纹色 | | |

| | | | |
|-----|--|---|----------------------------|
| 落地式 | LBEA***RKL 奶茶色 搭配支脚 DZ708 香槟色 | 长度: 600mm 长度: 800mm 长度: 900mm 长度: 1000mm | 奶茶色 摩卡色 浅木纹色 深木纹色 |
| | LBEA***RKC 摩卡色 搭配支脚 DZ705 黑色 | | |
| | LBEA***RMW 浅木纹色 搭配支脚 DZ705 黑色 | | |
| | LBEA***RMD 深木纹色 搭配支脚 DZ705 黑色 | | |

陶瓷一体洗面器

置物款

尽在掌握

- ① < 左右侧皆可置物 >
- ② < 倾斜设计下水迅速 >
- ③ < 溢水口隐藏设计 >



洗面器左、右侧皆可置物，方便放置日常常用物品。

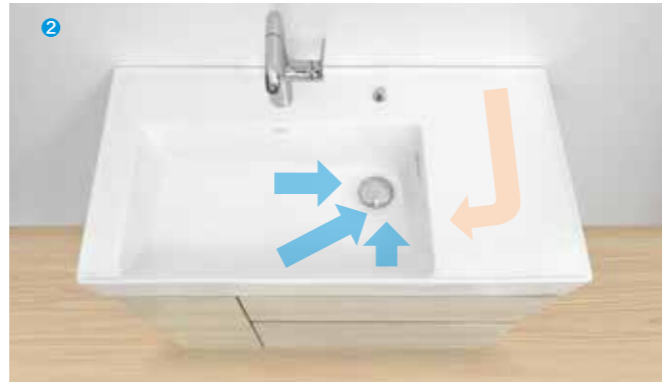

洗面器倾斜设计，下水迅速。



溢水口侧边隐藏设计，外观更简洁。

大容量款

大有可为

- ① < 大容量不易溅水 >
- ② < 深度设计方便洗头 >
- ③ < 干湿分离节水环保 >

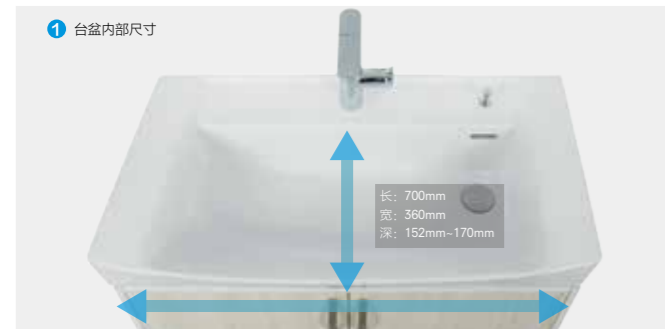

既宽又深的陶瓷洗面器，最深处达 170mm，方便使用的同时不易溅水。

*900mm 尺寸为例

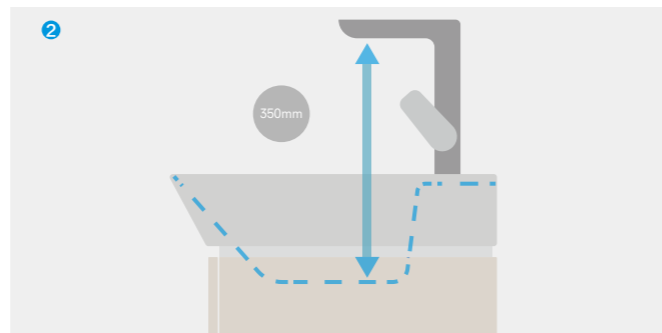

搭配抽拉水嘴，总深度达到 350mm，方便洗头。



右边蓄水清洗物品，左边临时放置物品；干湿分离，节水环保。

易清扫设计

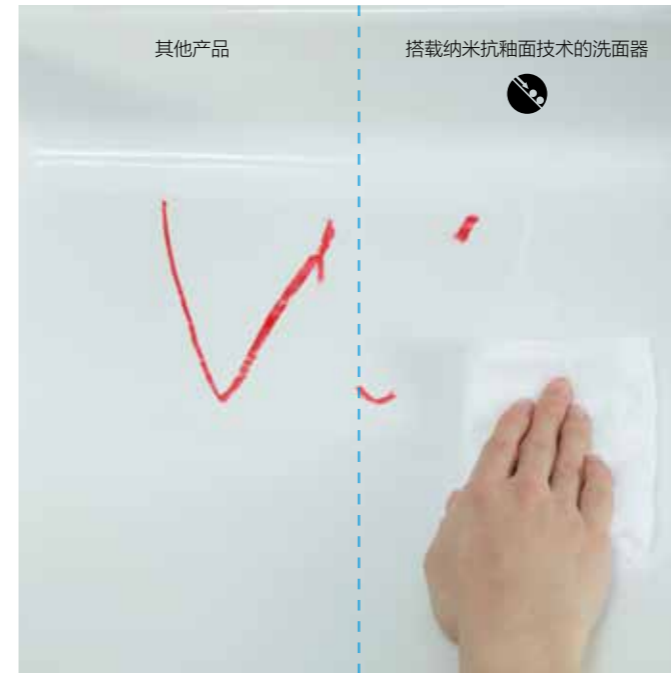

智洁。洗面器采用纳米抗污釉面技术，轻松去除污垢，长时间保持清洁。
*此处其他产品是指我以往部分型号产品



排水口自带集发器，省去堵塞烦恼



采用抗菌·防霉树脂材质。为了维持部件的最佳效果，需要定期进行维护。
*此处常规产品是指我以往部分型号产品

抽拉式水嘴



搭配抽拉水嘴，方便清洁角落等难以清扫的区域。



泡沫吐水技术；出水流畅，水流温和。

功能介绍

LBDA 型号系列设计亮点



采用 E1 级多层实木板，环保材质，使用更放心。



利用柜体下方空间，可收纳体重秤，扫地机器人等日常用品。



可根据自己的喜好，选择不同安装方式。

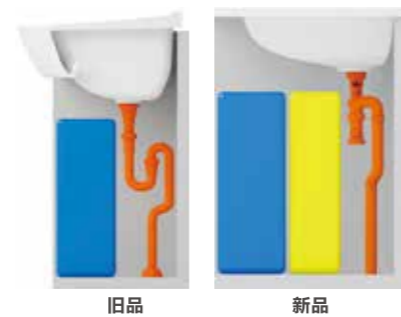

排水管位置后移，提升收纳空间。
*此处旧品是指我可以往部分型号产品

LBEA 型号系列设计亮点



左侧抽屉内置深浅两款收纳小盒，适合放置各类小物品，均可取出使用。



右侧上下两层抽屉设计，日常生活用品大多可以轻松收纳。



可根据自己的喜好，选择不同安装方式。

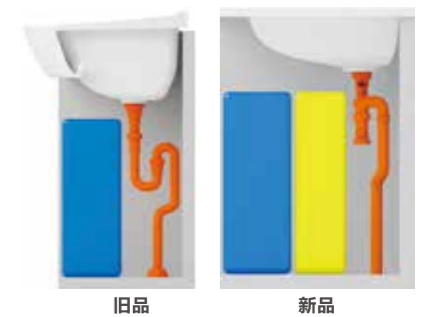

排水管位置后移，提升收纳空间。
*此处旧品是指我可以往部分型号产品

陶瓷一体型台盆柜

| | | | |
|---|---|----------------------------------|---|
|  | LMFC060SLHWC (白色) LMFC060SLHKD (深灰色) | 化妆镜柜 (带照明、带防雾) 600*175*750mm | |
| | TLG12303B | 铜合金台式单柄双控洗面器抽取式水嘴 |   |
| | LW846CB#XW (大容量款) | 一体式陶瓷洗面器 |  |
| | LBDA060KL (奶茶色) LBDA060KC (摩卡色) | 台盆柜 593*500*850mm (含支脚) | |
| | DZ707 (搭配奶茶色柜体) DZ706 (搭配摩卡色柜体) | 支脚 (4个) 248-264mm (可调节范围) | * 挂墙款无需订购支脚 |
|  | LMFC080SLHWC (白色) LMFC080SLHKD (深灰色) | 化妆镜柜 (带照明、带防雾) 800*175*750mm | |
| | TLS073J0C | 台式单柄双控洗面器抽取式水嘴 |  |
| | LW848CB#XW (大容量款) LW928CB#XW (置物款) | 一体式陶瓷洗面器 |  |
| | LBDA080KL (奶茶色) LBDA080KC (摩卡色) | 台盆柜 793*500*850mm (含支脚) | |
| | DZ707 (搭配奶茶色柜体) DZ706 (搭配摩卡色柜体) | 支脚 (4个) 248-264mm (可调节范围) | * 挂墙款无需订购支脚 |
|  | LMFC080SLHWC (白色) LMFC080SLHKD (深灰色) | 化妆镜柜 (带照明、带防雾) 800*175*750mm | |
| | TLG12303B | 铜合金台式单柄双控洗面器抽取式水嘴 |   |
| | LW849CB#XW (大容量款) LW929CB#XW (置物款) | 一体式陶瓷洗面器 |  |
| | LBDA090KL (奶茶色) LBDA090KC (摩卡色) | 台盆柜 893*500*850mm (含支脚) | |
| | DZ707 (搭配奶茶色柜体) DZ706 (搭配摩卡色柜体) | 支脚 (4个) 248-264mm (可调节范围) | * 挂墙款无需订购支脚 |
|  | LMFC100SLHWC (白色) LMFC100SLHKD (深灰色) | 化妆镜柜 (带照明、带防雾) 1000*175*750mm | |
| | TLS073J0C | 台式单柄双控洗面器抽取式水嘴 |  |
| | LW840CB#XW (大容量款) LW920CB#XW (置物款) | 一体式陶瓷洗面器 |  |
| | LBDA100KL (奶茶色) LBDA100KC (摩卡色) | 台盆柜 993*500*850mm (含支脚) | |
| | DZ707 (搭配奶茶色柜体) DZ706 (搭配摩卡色柜体) | 支脚 248-264mm (可调节范围) | * 挂墙款无需订购支脚 |

| | | | |
|---|---|----------------------------------|---|
|  | LMFC060SLHWC (白色) LMFC060SLHKD (深灰色) | 化妆镜柜 (带照明、带防雾) 600*175*750mm | |
| | TLG12303B | 铜合金台式单柄双控洗面器抽取式水嘴 |   |
| | LW846CB#XW (大容量款) | 一体式陶瓷洗面器 |  |
| | LBDA060MW (浅木纹色) LBDA060MD (深木纹色) | 台盆柜 593*500*850mm (含支脚) | |
| | DZ707 (搭配浅木纹色柜体) DZ706 (搭配深木纹色柜体) | 支脚 (4个) 248-264mm (可调节范围) | * 挂墙款无需订购支脚 |
|  | LMFC080SLHWC (白色) LMFC080SLHKD (深灰色) | 化妆镜柜 (带照明、带防雾) 800*175*750mm | |
| | TLS073J0C | 台式单柄双控洗面器抽取式水嘴 |  |
| | LW848CB#XW (大容量款) LW928CB#XW (置物款) | 一体式陶瓷洗面器 |  |
| | LBDA080MW (浅木纹色) LBDA080MD (深木纹色) | 台盆柜 793*500*850mm (含支脚) | |
| | DZ707 (搭配浅木纹色柜体) DZ706 (搭配深木纹色柜体) | 支脚 (4个) 248-264mm (可调节范围) | * 挂墙款无需订购支脚 |
|  | LMFC080SLHWC (白色) LMFC080SLHKD (深灰色) | 化妆镜柜 (带照明、带防雾) 800*175*750mm | |
| | TLG12303B | 铜合金台式单柄双控洗面器抽取式水嘴 |   |
| | LW849CB#XW (大容量款) LW929CB#XW (置物款) | 一体式陶瓷洗面器 |  |
| | LBDA090MW (浅木纹色) LBDA090MD (深木纹色) | 台盆柜 893*500*850mm (含支脚) | |
| | DZ707 (搭配浅木纹色柜体) DZ706 (搭配深木纹色柜体) | 支脚 (4个) 248-264mm (可调节范围) | * 挂墙款无需订购支脚 |
|  | LMFC100SLHWC (白色) LMFC100SLHKD (深灰色) | 化妆镜柜 (带照明、带防雾) 1000*175*750mm | |
| | TLS073J0C | 台式单柄双控洗面器抽取式水嘴 |  |
| | LW840CB#XW (大容量款) LW920CB#XW (置物款) | 一体式陶瓷洗面器 |  |
| | LBDA100MW (浅木纹色) LBDA100MD (深木纹色) | 台盆柜 993*500*850mm (含支脚) | |
| | DZ707 (搭配浅木纹色柜体) DZ706 (搭配深木纹色柜体) | 支脚 248-264mm (可调节范围) | * 挂墙款无需订购支脚 |

陶瓷一体型台盆柜

| | | | |
|---|---|------------------------------------|---|
|  | LMFC060SPHWC (白色) LMFC060SPHKD (深灰色) | 化妆镜柜 (带感应照明、带防雾) 600*175*750mm | |
| | TLG12303B | 铜合金台式单柄双控洗面器抽取式水嘴 |   |
| | LW846CB#XW (大容量款) | 一体式陶瓷洗面器 |  |
| | LBEA060KL (奶茶色) LBEA060KC (摩卡色) | 台盆柜 593*500*850mm (含支脚) | |
| | DZ708 (搭配奶茶色柜体) DZ705 (搭配摩卡色柜体) | 支脚 (4个) 140-156mm (可调节范围) | * 挂墙款无需订购支脚 |
|  | LMFC080SPHWC (白色) LMFC080SPHKD (深灰色) | 化妆镜柜 (带感应照明、带防雾) 800*175*750mm | |
| | TLS073J0C | 台式单柄双控洗面器抽取式水嘴 |  |
| | LW848CB#XW (大容量款) LW928CB#XW (置物款) | 一体式陶瓷洗面器 |  |
| | LBEA080RKL (奶茶色) LBEA080RKC (摩卡色) | 台盆柜 793*500*850mm (含支脚) | |
| | DZ708 (搭配奶茶色柜体) DZ705 (搭配摩卡色柜体) | 支脚 (4个) 140-156mm (可调节范围) | * 挂墙款无需订购支脚 |
|  | LMFC080SPHWC (白色) LMFC080SPHKD (深灰色) | 化妆镜柜 (带感应照明、带防雾) 800*175*750mm | |
| | TLG12303B | 铜合金台式单柄双控洗面器抽取式水嘴 |   |
| | LW849CB#XW (大容量款) LW929CB#XW (置物款) | 一体式陶瓷洗面器 |  |
| | LBEA090RKL (奶茶色) LBEA090RKC (摩卡色) | 台盆柜 893*500*850mm (含支脚) | |
| | DZ708 (搭配奶茶色柜体) DZ705 (搭配摩卡色柜体) | 支脚 (4个) 140-156mm (可调节范围) | * 挂墙款无需订购支脚 |
|  | LMFC100SPHWC (白色) LMFC100SPHKD (深灰色) | 化妆镜柜 (带感应照明、带防雾) 1000*175*750mm | |
| | TLS073J0C | 台式单柄双控洗面器抽取式水嘴 |  |
| | LW840CB#XW (大容量款) LW920CB#XW (置物款) | 一体式陶瓷洗面器 |  |
| | LBEA100RKL (奶茶色) LBEA100RKC (摩卡色) | 台盆柜 993*500*850mm (含支脚) | |
| | DZ708 (搭配奶茶色柜体) DZ705 (搭配摩卡色柜体) | 支脚 (4个) 140-156mm (可调节范围) | * 挂墙款无需订购支脚 |

| | | | |
|---|---|------------------------------------|---|
|  | LMFC060SPHWC (白色) LMFC060SPHKD (深灰色) | 化妆镜柜 (带感应照明、带防雾) 600*175*750mm | |
| | TLG12303B | 铜合金台式单柄双控洗面器抽取式水嘴 |   |
| | LW846CB#XW (大容量款) | 一体式陶瓷洗面器 |  |
| | LBEA060MW (浅木纹色) LBEA060MD (深木纹色) | 台盆柜 593*500*850mm (含支脚) | |
| | DZ705 | 支脚 (4个) 140-156mm (可调节范围) | * 挂墙款无需订购支脚 |
|  | LMFC080SPHWC (白色) LMFC080SPHKD (深灰色) | 化妆镜柜 (带感应照明、带防雾) 800*175*750mm | |
| | TLS073J0C | 台式单柄双控洗面器抽取式水嘴 |  |
| | LW848CB#XW (大容量款) LW928CB#XW (置物款) | 一体式陶瓷洗面器 |  |
| | LBEA080RMW (浅木纹色) LBEA080RMD (深木纹色) | 台盆柜 793*500*850mm (含支脚) | |
| | DZ705 | 支脚 (4个) 140-156mm (可调节范围) | * 挂墙款无需订购支脚 |
|  | LMFC080SPHWC (白色) LMFC080SPHKD (深灰色) | 化妆镜柜 (带感应照明、带防雾) 800*175*750mm | |
| | TLG12303B | 铜合金台式单柄双控洗面器抽取式水嘴 |   |
| | LW849CB#XW (大容量款) LW929CB#XW (置物款) | 一体式陶瓷洗面器 |  |
| | LBEA090RMW (浅木纹色) LBEA090RMD (深木纹色) | 台盆柜 893*500*850mm (含支脚) | |
| | DZ705 | 支脚 (4个) 140-156mm (可调节范围) | * 挂墙款无需订购支脚 |
|  | LMFC100SPHWC (白色) LMFC100SPHKD (深灰色) | 化妆镜柜 (带感应照明、带防雾) 1000*175*750mm | |
| | TLS073J0C | 台式单柄双控洗面器抽取式水嘴 |  |
| | LW840CB#XW (大容量款) LW920CB#XW (置物款) | 一体式陶瓷洗面器 |  |
| | LBEA100RMW (浅木纹色) LBEA100RMD (深木纹色) | 台盆柜 993*500*850mm (含支脚) | |
| | DZ705 | 支脚 (4个) 140-156mm (可调节范围) | * 挂墙款无需订购支脚 |

陶瓷一体型台盆柜

| | | | |
|---|---|-------------------------------------|---|
|  | LMBA080MD (深枫木色) LMBA080WC (奶白色) | 化妆镜柜 800*133*640mm | |
| | TLS083J0C | 台式单柄双控洗面器抽取式水嘴 | 🚰 |
| | LDGA080LMD (左开放) LDGA080RMD (右开放) (白岩纹色 x 深枫木色) | 挂墙款台盆柜 (含一体式陶瓷洗面器) 800*500*525mm | |
| | LDGA080LKL (左开放) LDGA080RKL (右开放) (白岩纹色 x 高雅灰色) | | |

| | | | |
|---|---|-------------------------------------|---|
|  | LMBA090MD (深枫木色) LMBA090WC (奶白色) | 化妆镜柜 900*133*640mm | |
| | TLS083J0C | 台式单柄双控洗面器抽取式水嘴 | 🚰 |
| | LDGA090LMD (左开放) LDGA090RMD (右开放) (白岩纹色 x 深枫木色) | 挂墙款台盆柜 (含一体式陶瓷洗面器) 900*500*525mm | |
| | LDGA090LKL (左开放) LDGA090RKL (右开放) (白岩纹色 x 高雅灰色) | | |

| | | | |
|--|---|--------------------------------------|---|
|  | LMBA100MD (深枫木色) LMBA100WC (奶白色) | 化妆镜柜 1000*133*640mm | |
| | TLS083J0C | 台式单柄双控洗面器抽取式水嘴 | 🚰 |
| | LDGA100LMD (左开放) LDGA100RMD (右开放) (白岩纹色 x 深枫木色) | 挂墙款台盆柜 (含一体式陶瓷洗面器) 1000*500*525mm | |
| | LDGA100LKL (左开放) LDGA100RKL (右开放) (白岩纹色 x 高雅灰色) | | |

| | | | |
|---|--------------------------------------|-------------------------------------|---|
|  | LMBA060MD (深枫木色) LMBA060WC (奶白色) | 化妆镜柜 600*133*640mm | |
| | TLS083J0C | 台式单柄双控洗面器抽取式水嘴 | 🚰 |
| | LDFA060MD (深枫木色) LDFA060KL (浅米咖色) | 挂墙款台盆柜 (含一体式陶瓷洗面器) 600*500*535mm | |
| | | | |

| | | | |
|---|--------------------------------------|-------------------------------------|---|
|  | LMBA070MD (深枫木色) LMBA070WC (奶白色) | 化妆镜柜 700*133*640mm | |
| | TLS083J0C | 台式单柄双控洗面器抽取式水嘴 | 🚰 |
| | LDFA070MD (深枫木色) LDFA070KL (浅米咖色) | 挂墙款台盆柜 (含一体式陶瓷洗面器) 700*500*535mm | |
| | | | |

| | | | |
|--|--------------------------------------|-------------------------------------|---|
|  | LMBA080MD (深枫木色) LMBA080WC (奶白色) | 化妆镜柜 800*133*640mm | |
| | TLS083J0C | 台式单柄双控洗面器抽取式水嘴 | 🚰 |
| | LDFA080MD (深枫木色) LDFA080KL (浅米咖色) | 挂墙款台盆柜 (含一体式陶瓷洗面器) 800*500*535mm | |
| | | | |

| | | | |
|---|--------------------------------------|-------------------------------------|---|
|  | LMBA090MD (深枫木色) LMBA090WC (奶白色) | 化妆镜柜 900*133*640mm | |
| | TLS083J0C | 台式单柄双控洗面器抽取式水嘴 | 🚰 |
| | LDFA090MD (深枫木色) LDFA090KL (浅米咖色) | 挂墙款台盆柜 (含一体式陶瓷洗面器) 900*500*535mm | |
| | | | |

| | | | |
|---|--------------------------------------|--------------------------------------|---|
|  | LMBA100MD (深枫木色) LMBA100WC (奶白色) | 化妆镜柜 1000*133*640mm | |
| | TLS083J0C | 台式单柄双控洗面器抽取式水嘴 | 🚰 |
| | LDFA100MD (深枫木色) LDFA100KL (浅米咖色) | 挂墙款台盆柜 (含一体式陶瓷洗面器) 1000*500*535mm | |
| | | | |

深型台盆柜

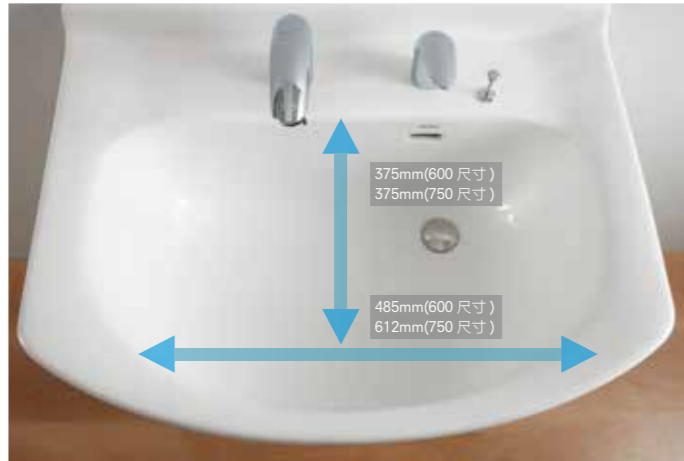

大容量陶瓷台盆，方便清洗大件衣物。采用纳米抗污釉面技术，污垢不易附着。



宽敞、平稳的台盆底面，可将洗脸盆放置在台盆内使用。



可在淋浴出水、柔和出水之间自由切换，满足你的不同清洗需求。



淋浴出水



柔和出水

镜柜功能介绍



柜门背镜，打开时方便靠近使用。



触控开启照明，长按可根据使用场景调节亮度。



触控开启防雾，潮湿环境中，防雾部分保持清晰。

触控式化妆镜柜



LMFD060SPHWC (白色)
LMFD060SPHKD (深灰色)

化妆镜柜 (带触控照明、带防雾)
600*146*750mm



LMFD080SPHWC (白色)
LMFD080SPHKD (深灰色)

化妆镜柜 (带触控照明、带防雾)
800*146*750mm



LMFD100SPHWC (白色)
LMFD100SPHKD (深灰色)

化妆镜柜 (带触控照明、带防雾)
1000*146*750mm



* 所标示尺寸为盆体内部尺寸。

镜柜功能介绍



2 防雾功能

电加热防雾功能，在潮湿环境中开启，防雾部分镜面保持清晰，洗漱更方便。



1 免接触感应照明

在镜柜下方的位置，通过手部感应，轻松开启照明。（* 仅 LMFC***SPH 系列）

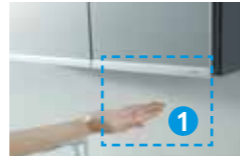

3 放大镜

可根据使用情况，灵活调节放大镜角度。



4 吹风机支架

方便收纳吹风机。

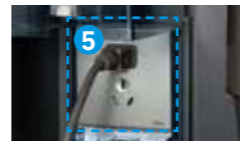

5 内置插座

可供电动牙刷，剃须刀等充电。
* 最终式样以实物为准



6 收纳小盒

镜柜内置收纳小盒，方便收纳化妆品，并可取出使用。

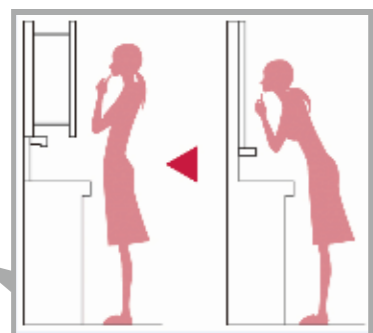

7 摆动式设计

可根据使用情况，将镜子移至面前，让化妆姿势更轻松。



8 双开门设计

左右两侧均可开门，方便取放物品。

摆动式化妆镜柜



LMFC060SPHWC (白色)
LMFC060SPHKD (深灰色)

化妆镜柜 (带感应照明、带防雾)
600*175*750mm



LMFC060SLHWC (白色)
LMFC060SLHKD (深灰色)

化妆镜柜 (带照明、带防雾)
600*175*750mm



LMFC080SPHWC (白色)
LMFC080SPHKD (深灰色)

化妆镜柜 (带感应照明、带防雾)
800*175*750mm



LMFC080SLHWC (白色)
LMFC080SLHKD (深灰色)

化妆镜柜 (带照明、带防雾)
800*175*750mm



LMFC100SPHWC (白色)
LMFC100SPHKD (深灰色)

化妆镜柜 (带感应照明、带防雾)
1000*175*750mm













LMFC100SLHWC (白色)
LMFC100SLHKD (深灰色)











化妆镜柜 (带照明、带防雾)
1000*175*750mm

* 以上为 LMFC 型号系列镜柜功能

开放式化妆镜柜

| | | | |
|---|-------------------------------------|------------------------------|---|
|  | LMBA060MD (深枫木色) LMBA060WC (奶白色) | 化妆镜柜 (仅收纳) 600*133*640mm |  |
|  | LMBA070MD (深枫木色) LMBA070WC (奶白色) | 化妆镜柜 (仅收纳) 700*133*640mm |  |
|  | LMBA080MD (深枫木色) LMBA080WC (奶白色) | 化妆镜柜 (仅收纳) 800*133*640mm |  |
|  | LMBA090MD (深枫木色) LMBA090WC (奶白色) | 化妆镜柜 (仅收纳) 900*133*640mm |  |
|  | LMBA100MD (深枫木色) LMBA100WC (奶白色) | 化妆镜柜 (仅收纳) 1000*133*640mm |  |

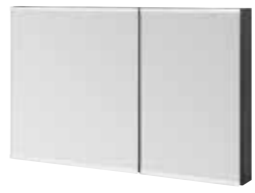
化妆镜柜

| | | | |
|---|---|------------------------------|---|
|  | LMFC060GGGWC (白色) LMFC060GGGKD (深灰色) | 化妆镜柜 (仅收纳) 600*136*640mm |  |
|  | LMFC070GGGWC (白色) LMFC070GGGKD (深灰色) <small>NEW</small> | 化妆镜柜 (仅收纳) 700*136*640mm |  |
|  | LMFC080GGGWC (白色) LMFC080GGGKD (深灰色) | 化妆镜柜 (仅收纳) 800*136*640mm |  |
|  | LMFC090GGGWC (白色) LMFC090GGGKD (深灰色) <small>NEW</small> | 化妆镜柜 (仅收纳) 900*136*640mm |  |
|  | LMFC100GGGWC (白色) LMFC100GGGKD (深灰色) | 化妆镜柜 (仅收纳) 1000*136*640mm |  |

单面化妆镜

| | | |
|---|--|--|
|  | LMCA060G1GGGWC (白色) LMCA075G1GGGWC (白色) | 化妆镜 600*116*800mm 化妆镜 750*116*800mm |
|  | LMCA060G1GGGKD (深灰色) LMCA075G1GGGKD (深灰色) | 化妆镜 600*116*800mm 化妆镜 750*116*800mm |



LAVATORY

推荐组合 RECOMMEND PRODUCTS

桌上式洗面器



LW1705B
桌上式洗面器
550*380*125mm



LW1735B
桌上式洗面器
550*380*125mm



半埋入式洗面器



LW1315B
半埋入台式洗面器
500*450mm



LW1316B
半埋入台式洗面器
550*450mm



LW533JUB
半埋入台式洗面器
430*430mm



台下式洗面器



LW1506B
台下式洗面器
590*380mm



LW1554B
台下式洗面器
538*380mm



LW1576B
台下式洗面器
590*430mm



LW1555B
台下式洗面器
588*380mm



LW1575B
台下式洗面器
550*380mm



LW1556B
台下式洗面器
588*430mm



持久洁净

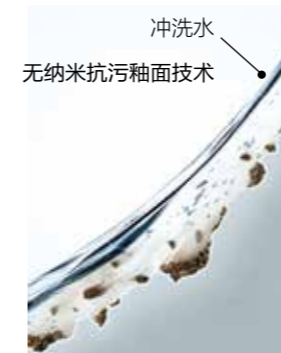

冲洗水
无纳米抗污釉面技术



冲洗水
有纳米抗污釉面技术

冲洗时表面的断面放大示意图

纳米抗污釉面技术

采用纳米抗污技术的釉面空隙小于纳米水平，几乎不给污垢容身空间，具有经久耐用的品质。

精致台盆空间

面对日趋紧凑、精致的浴室空间，TOTO 的洗面器可灵活对应多种台面径深，让您的浴室空间更具和谐美感。



台面径深 600mm
应用场景：住宅、酒店、公共空间



台面径深 550mm
应用场景：住宅、酒店

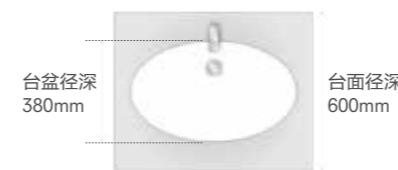

台盆径深 380mm 台面径深 600mm



台盆径深 380mm 台面径深 550mm



晶雅石材质洗面器



PJS05W (#GW/#MW) (高光/哑光)

晶雅石材质洗面器 (桌上式)
600*380*120mm
已安装提拉式排水金具



PJS06W (#GW/#MW) (高光/哑光)

晶雅石材质洗面器 (桌上式)
600*380*120mm
已安装提拉式排水金具



PJS07W (#GW/#MW) (高光/哑光)

晶雅石材质洗面器 (桌上式)
600*380*150mm
已安装提拉式排水金具



PJS04W (#GW/#MW) (高光/哑光)

晶雅石材质洗面器 (桌上式)
Ø450*160mm
已安装按启式排水金具



PJS04W (#MGB) (曜石黑)

晶雅石材质洗面器 (桌上式)
Ø450*160mm
已安装按启式排水金具



PJS01W (#GW/#MW) (高光/哑光)

晶雅石材质洗面器 (桌上式)
632*404*154mm
已安装按启式排水金具



PJS02W (#GW/#MW) (高光/哑光)

晶雅石材质洗面器 (桌上式)
600*400*120mm
已安装按启式排水金具



PJS03W (#GW/#MW) (高光/哑光)

晶雅石材质洗面器 (桌上式)
600*400*120mm
已安装按启式排水金具

纤翼

LINEARCERAM

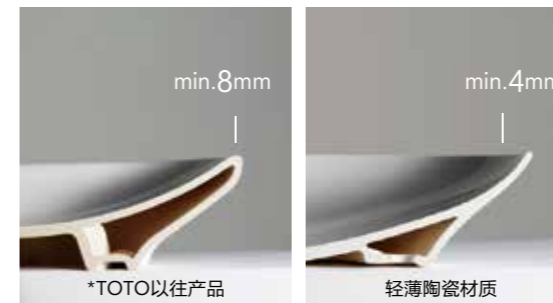

轻薄陶瓷材质

轻薄陶瓷材质由 TOTO 独特的配方调和而成，可以实现超薄的形状以及强调直线，平面等利落造型设计。



LW4704B

桌上式洗面器
460*420*130mm



reddot winner 2020



LW4715RB

桌上式洗面器
500*380*70mm



iF DESIGN AWARD 2017



LW4716RB

桌上式洗面器
600*380*70mm



iF DESIGN AWARD 2017



LW4706B

桌上式洗面器
600*420*90mm



iF DESIGN AWARD 2017

CONSOLE LAVATORY | 桌上式洗面器

UNDERCOUNTER LAVATORY | 台下式洗面器



LW1705B

桌上式洗面器
550*380*125mm



LW1735B

桌上式洗面器
550*380*125mm



LW5715B

桌上式洗面器
500*380*70mm



LW5716B

桌上式洗面器
600*380*70mm



LW1505B

台下式洗面器
500*380mm



LW1506B

台下式洗面器
590*380mm



LW1535B

台下式洗面器
500*380mm



LW1536B

台下式洗面器
590*380mm



LW1715B

桌上式洗面器
500*370*60mm



LW1716B

桌上式洗面器
600*385*65mm



LW709CB (单孔水嘴用)
LW709B (8英寸水嘴用)

桌上式洗面器
500*450*135mm



LW711RCB (单孔水嘴用)
LW711RB (8英寸水嘴用)

桌上式洗面器
600*500*135mm



LW2516B

台下式洗面器
626*446mm



LW537RB

台下式洗面器
470*380mm



LW546B

台下式洗面器
550*400mm



LW588RB

台下式洗面器
560*430mm



LW1704B

桌上式洗面器
Ø400*60mm



LW1706B

桌上式洗面器
Ø400*125mm



LW523B

桌上式洗面器
Ø430*150mm



LW548B

台下式洗面器
600*420mm



LW1555B

台下式洗面器
588*380mm



NEW



LW1575B

台下式洗面器
550*380mm



NEW



LW1556B

台下式洗面器
588*430mm



NEW

LAVATORY | 洗面器

UNDERCOUNTER LAVATORY | 台下式洗面器



LW1554B

LW1576B

台下式洗面器
538*380mm

台下式洗面器
590*430mm

NEW

NEW



WALL HUNG LAVATORY | 壁挂式洗面器



LWN251CB (单孔水嘴用)

壁挂式洗面器
560*460mm



SEMI RECESSED COUNTER LAVATORY | 半埋入台上式洗面器



LW1315CB (单孔水嘴用)
LW1315B (8英寸水嘴用)

LW1316CB (单孔水嘴用)
LW1316B (8英寸水嘴用)

LW983CB (单孔水嘴用)
LW983B (8英寸水嘴用)

LW533JUB

半埋入台上式洗面器
500*450mm

半埋入台上式洗面器
550*450mm

半埋入台上式洗面器
550*430mm

半埋入台上式洗面器
430*430mm



NEW



LW1634B (无溢水口)

桌上式洗手盆
400*230*120mm



LW1223B

壁挂式洗手盆
320*260*100mm



PEDESTAL LAVATORY | 立柱式洗面器



LWN251CB/LWN220FRB (单孔水嘴用)

立柱式洗面器
560*460*860mm





森绿色

橘黄色

绯红色

雾蓝色



LW896JBWF#FRG
桌上式洗面器
620*430*130mm



LW896JBWF#MDR
桌上式洗面器
620*430*130mm



LW896JBWF#SCR
桌上式洗面器
620*430*130mm



LW896JBWF#ASB
桌上式洗面器
620*430*130mm



LW630JBWF#FRG
桌上式洗面器
600*370*110mm



LW630JBWF#MDR
桌上式洗面器
600*370*110mm



LW630JBWF#SCR
桌上式洗面器
600*370*110mm



LW630JBWF#ASB
桌上式洗面器
600*370*110mm



*此展示仅代表颜色；相同的颜色名称，根据商品材料和材质的不同，颜色也可能存在差异。



COLOURFUL VARIATION 多样化的颜色选择

COLOURFUL VARIATION | 多样化的颜色选择



LW4704B#MBE(哑光米)

桌上式洗面器
460*420*130mm



LW4706B#MW(哑光白)

桌上式洗面器
600*420*90mm



LW4715RB#MBL(哑光黑)

桌上式洗面器
500*380*70mm



LW4716RB#MGR(哑光灰)

桌上式洗面器
600*380*70mm



LW1705B#MBL(哑光黑)

桌上式洗面器
550*380*125mm



LW1735B#MW(哑光白)







桌上式洗面器
550*380*125mm





*此展示仅代表颜色；相同的颜色名称，根据商品材料和材质的不同，颜色也可能存在差异。

*桌上式洗面器标注高度为洗面器露出桌面的高度

洗面器与水嘴颜色推荐搭配一览表

| 型号 | 颜色 | Z系列水嘴 | | | G系列水嘴 | | | | | | | | | |
|---|---------|-------|-----|------|-------|------|------|------|------|------|------|------|------|------|
| | | ZN系列 | | ZA系列 | GE系列 | GT系列 | | GB系列 | GF系列 | GA系列 | | GR系列 | | GS系列 |
| | | 镀铬 | #BN | #BN | #BN | #BN | #MBL | #MBL | #MBL | #BN | #MBL | #BN | #MBL | #MBL |
|  | 哑光白#MW | | ◎ | × | ○ | ○ | | | | ○ | | ○ | | |
| | 哑光黑#MBL | ○ | | × | | | ○ | ○ | ○ | | ○ | | ○ | ○ |
| | 哑光米#MBE | | ○ | × | ○ | ○ | | | | ○ | | ○ | | |
| | 哑光灰#MGR | ○ | | × | | | ○ | ○ | ○ | | ○ | | ○ | ○ |
|  | 哑光白#MW | | ○ | × | ○ | ○ | | | | ○ | | ○ | | |
| | 哑光黑#MBL | ○ | | × | | | ○ | ◎ | ○ | | ○ | | ○ | ○ |
| | 哑光米#MBE | | ○ | × | ○ | ○ | | | | ○ | | ○ | | |
| | 哑光灰#MGR | ○ | | × | | | ○ | ○ | ○ | | ○ | | ○ | ○ |
|  | 哑光白#MW | | ○ | × | ○ | ○ | | | | ○ | | ○ | | |
| | 哑光黑#MBL | ○ | | × | | | ○ | ○ | ○ | | ○ | | ○ | ○ |
| | 哑光米#MBE | | ○ | × | ○ | ○ | | | | ○ | | ○ | | |
| | 哑光灰#MGR | ○ | | × | | | ○ | ◎ | ○ | | ○ | | ○ | ○ |
|  | 哑光白#MW | × | × | ◎ | ○ | ○ | | | | ○ | | ○ | | |
| | 哑光黑#MBL | × | × | | | | ○ | ○ | ○ | | ○ | | ○ | ○ |
| | 哑光米#MBE | × | × | ○ | ○ | ○ | | | | ○ | | ○ | | |
| | 哑光灰#MGR | × | × | | | | ○ | ○ | ○ | | ○ | | ○ | ○ |
|  | 哑光白#MW | × | × | ○ | ○ | ○ | | | | ○ | | ○ | | |
| | 哑光黑#MBL | × | × | | | | ○ | ○ | ◎ | | ○ | | ○ | ○ |
| | 哑光米#MBE | × | × | ○ | ○ | ○ | | | | ○ | | ○ | | |
| | 哑光灰#MGR | × | × | | | | ○ | ○ | ○ | | ○ | | ○ | ○ |
|  | 哑光白#MW | × | × | ○ | ○ | ○ | | | | ○ | | ◎ | | |
| | 哑光黑#MBL | × | × | | | | ○ | ○ | ○ | | ○ | | ○ | ○ |
| | 哑光米#MBE | × | × | ○ | ○ | ○ | | | | ○ | | ○ | | |
| | 哑光灰#MGR | × | × | | | | ○ | ○ | ○ | | ○ | | ○ | ○ |

“◎”为图示搭配 “○”为推荐搭配 “ ”为不推荐搭配 “×”为不可安装

| 型号 | 款式 | 洗面器颜色 | 推荐水嘴系列 | 推荐水嘴颜色 |
|-----------|---|---------|--------|--------|
| LW896JBWF |  | 森绿色#FRG | GE系列 | #BN |
| |  | 橘黄色#MDR | GA系列 | #BN |
| |  | 绯红色#SCR | GE系列 | #PFG |
| |  | 雾蓝色#ASB | GA系列 | #BTN |
| LW630JBWF |  | 森绿色#FRG | GR系列 | #BN |
| |  | 橘黄色#MDR | GC系列 | #PBR |
| |  | 绯红色#SCR | GB系列 | #BGP |
| |  | 雾蓝色#ASB | GB系列 | #BTN |

*以上为推荐搭配。
*除ZN系列，其他系列水嘴也可自由选择。



FAUCET

舒芯

COMFORT GLIDE



舒适耐用水嘴阀芯



易于使用，让操作更简单。

TOTO 认为舒适不仅仅是环境舒适，持久易用也是舒适感的一部分。基于这一目的，TOTO 为用户设置了特别的阀芯。本设计从根本上为简化操作提供了基础。



特殊涂层增加舒适感。

特殊的金刚石状碳包覆陶瓷涂层上，阀芯历久如新，并且优于传统的润滑油阀芯。

2 HANDLE FAUCET BURN PREVENTION | 双柄双控水嘴

让你的使用更安心。

我们会考虑容易被烫伤的使用场景，然后反推决定所需要的表面温度。比如，当 90 度的热水流过时，我们设定了让那个区域的手触碰温度维持在 45 度（接近淋浴温度）或更低。

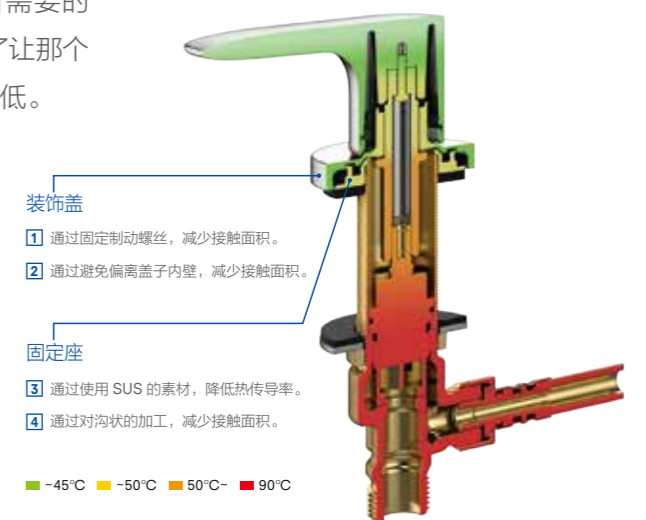

采用安全施工法以及安全材料控制水嘴表面温度

当使用热水时，比如为浴缸加入热水时，水的热量会传递到手柄，这不仅增加了烫伤的风险而且会导致手柄过热而自动关闭水流。TOTO 研究了热传递到手柄的原因，在双柄双控水嘴设计中采用了可减少热传递的方法和材料。我们的新型双柄双控水嘴（浴缸专用）都具备这种高度安全的特性。

Matte Black(PVD)

哑光黑 (PVD 电镀技术)

低调奢华的光泽感，
出色的产品硬度。



令人惊叹的哑光黑表面赋予了水嘴优雅与精致。丝滑、细腻的光泽色调，尽显低调的奢华。

水嘴表面不规则处采用“喷砂工艺”技术，随后进行镀铬，最后通过 PVD 电镀技术（物理气相沉积）呈现出既有光泽又带纤细质感的哑光黑表面。

PVD 产品的表面硬度优于喷涂表面

与喷涂产品相比，TOTO PVD 产品不易留下使用划痕，其表面的涂层也不容易出现剥落的情况。

铅笔硬度测试

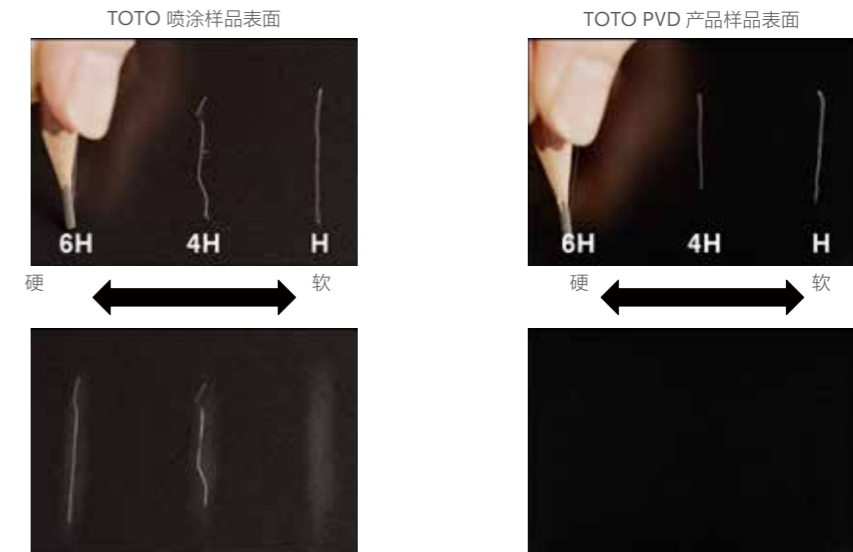

即便使用 6H 硬度的铅笔进行测试，PVD 哑光黑表面也未留下划痕。

测试条件：

在测试现场对 TOTO 喷涂样品 /TOTO PVD 产品样品表面进行了铅笔硬度测试（符合 GB/T 6739-2022）。

什么是 TOTO 哑光黑 PVD 电镀技术

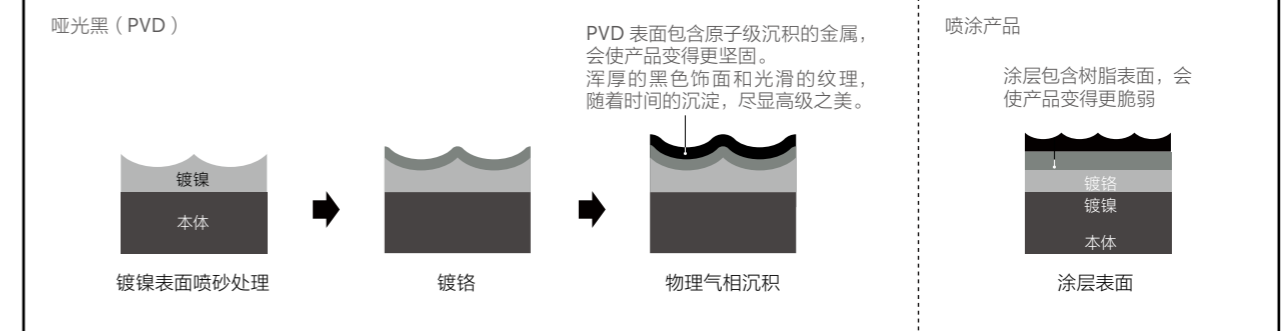



多彩颜色和丰富工艺

丰富多彩的颜色和多样的工艺，装点精心设计的空间。

通过 PVD 电镀技术，在水嘴表面沉积出动人色彩，形成即具美感又不失质感的坚固表面。同时，更为卫浴空间增添了一份动人的多彩魅力。



镀铬



拉丝镍



抛光法兰金



抛光铜色



抛光玫瑰金



拉丝石墨灰



拉丝钛灰



相同的颜色名称，根据商品材料和材质的不同，颜色也可能存在差异。



ZA series

reddot award 2019
winner

同时采用不对称设计的龙头和手柄，
与洗面器组成上佳的搭配，彼此交相辉映。

ZA 系列的手柄造型如花瓣
般轻薄灵动，与拥有纤
细曲线的洗面器相互衬托，这充满
魅力的设计构思，仿佛能使人感受
到清风的清新气息。
充满自然元素的空间，让每一天都
焕然一新。





TLP03301B
台式单柄双控洗面器水嘴
(附排水金具)



TLP03302B
台式单柄双控洗面器水嘴



拉丝镍
#BN



抛光法兰金
#PFG



抛光铜色
#PBR



镀铬



TBP03301C/TBN01105B
立式单柄双控浴缸水嘴 / 阀体



拉丝镍
#BN



镀铬
×
拉丝镍
#XAC

ZL series 

尽显轻薄、精致。
简洁干练的造型赋予空间以清澈、静谧的美感。

如 镜子般平滑的表面和纤薄的边缘线条在
平面上形成鲜明对比。

利用先进的工艺技术呈现出产品的精巧外形，在
设计理念上与方形洗面器一脉相承。



ZL系列的连绵水流配合轻柔触碰，呈现出优美线条，与设计精致的洗面器搭配，彼此相得益彰。

瀑 布状的水流仿佛与纤薄的出水口融为一体。

优雅高级的手柄操作得心应手。独具匠心的设计让出水及人的操作动作更具美感，与简约的方形洗面器相互衬托，将整个空间装点得更加丰富。





TLP02301B1
台式单柄双控洗面器水嘴
(含排水配件)



TLP02303B1
台式单柄双控洗面器水嘴
(不含排水配件)



TLP02304B1
台式单柄双控洗面器水嘴
(含排水配件)



TBP02301B1A/TBN01001C
壁式单柄双控暗装水嘴面板 / 阀体
(开闭切换)



TBP02302B1A/TBN01001C
壁式单柄双控暗装水嘴面板 / 阀体
(两种出水切换, 开闭切换)



TBP02001B1
吐水口



TLP02306B1
台式单柄双控洗面器水嘴
(不含排水配件)



TLP02307B1
台式单柄双控洗面器水嘴
(含排水配件)



TLP02308B1
台式单柄双控洗面器水嘴
(不含排水配件)



TBP02201B1A
台式双柄双控浴缸水嘴



TBP02202C
台式双柄双控浴缸水嘴
(带手持花洒)



TBP02303C/TBN01105B
立式单柄双控浴缸水嘴 / 阀体



TLP02309B1A
壁式单柄双控暗装洗面器水嘴
(不含排水配件)



TLP02310B1A
壁式单柄双控暗装洗面器水嘴
(不含排水配件)



TLP02201B1A
台式双柄双控洗面器水嘴
(含排水配件)



GE series



将植根于传统工艺中对于“美”的意识
升华为独特个性的造型美感。



独 特的V型边缘一直延伸到出水口
前端。

明亮的多面体反射营造出丰富的视觉效果。
金色抛光表面光彩夺目，使整个设计
更显独特奢华。

演绎出令人惊喜的超现代空间。





TLG07301B#PFG (抛光法兰金)
TLG07301B#BN (拉丝镀铬)
TLG07301B (镀铬)

台式单柄双控洗面器水嘴
(附排水金具)



TLG07302B#PFG (抛光法兰金)
TLG07302B#BN (拉丝镀铬)
TLG07302B (镀铬)

台式单柄双控洗面器水嘴



TLG07303B#PFG (抛光法兰金)
TLG07303B#BN (拉丝镀铬)
TLG07303B (镀铬)

台式单柄双控洗面器水嘴
(附排水金具)



TBG07301BA#PFG (抛光法兰金)
TBG07301BA#BN (拉丝镀铬)
TBG07301BA (镀铬)

壁式单柄双控淋浴水嘴



TBG07302BA#PFG (抛光法兰金)
TBG07302BA#BN (拉丝镀铬)
TBG07302BA (镀铬)

壁式单柄双控浴缸水嘴



TBG07303BA#PFG (抛光法兰金)
TBG07303BA#BN (拉丝镀铬)
TBG07303BA (镀铬)
/TBN01001C

壁式单柄双控暗装
水嘴面板 / 阀体 (开闭切换)



TBG07304BA#PFG (抛光法兰金)
TBG07304BA#BN (拉丝镀铬)
TBG07304BA (镀铬)
/TBN01001C

壁式单柄双控暗装水嘴面板 / 阀体
(二种出水切换 / 开闭切换)



TLG07304B#PFG (抛光法兰金)
TLG07304B#BN (拉丝镀铬)
TLG07304B (镀铬)

台式单柄双控洗面器水嘴



TLG07305B#PFG (抛光法兰金)
TLG07305B#BN (拉丝镀铬)
TLG07305B (镀铬)

台式单柄双控洗面器水嘴
(附排水金具)



TLG07306B#PFG (抛光法兰金)
TLG07306B#BN (拉丝镀铬)
TLG07306B (镀铬)

台式单柄双控洗面器水嘴



TBG07001B#PFG (抛光法兰金)
TBG07001B#BN (拉丝镀铬)
TBG07001B (镀铬)

吐口水



TBG07201B#PFG (抛光法兰金)
TBG07201B#BN (拉丝镀铬)
TBG07201B (镀铬)

台式双柄双控浴缸水嘴



TBG07305C#PFG (抛光法兰金)
TBG07305C#BN (拉丝镀铬)
TBG07305C (镀铬)

台式单柄双控浴缸水嘴
(带手持花洒)



TBG07202C#PFG (抛光法兰金)
TBG07202C#BN (拉丝镀铬)
TBG07202C (镀铬)

台式双柄双控浴缸水嘴
(带手持花洒)



TLG07307C#PFG (抛光法兰金)
TLG07307C#BN (拉丝镀铬)
TLG07307C (镀铬)
/TLN033G0C

壁式单柄双控暗装水嘴 (短款)



TLG07308C#PFG (抛光法兰金)
TLG07308C#BN (拉丝镀铬)
TLG07308C (镀铬)
/TLN033G0C

壁式单柄双控暗装水嘴 (长款)



TLG07201BA#PFG (抛光法兰金)
TLG07201BA#BN (拉丝镀铬)
TLG07201BA (镀铬)

台式双柄双控洗面器水嘴
(附排水金具)



TBG07306C#PFG (抛光法兰金)
TBG07306C#BN (拉丝镀铬)
TBG07306C (镀铬)
/TBN01105B

立式单柄双控浴缸水嘴 / 阀体



GC series

采用双手柄设计，充分体现高级酒店的格调。
手柄与龙头统一的设计构思，演绎出丰富多彩的空间。

龙 头和手柄开关呈一直线，突出了设计的统一性。
三个底座的分割线可引出一条水平线，强调整体造型的间隔感。
将重心集中于底座部分的设计，与空间内装中的其他元素搭配不会产生突兀感，同时又增添一份稳重。





TLG08301B#PBR (抛光铜色)
TLG08301B (镀铬)
台式单柄双控洗面器水嘴
(附排水金具)



TLG08302B#PBR (抛光铜色)
TLG08302B (镀铬)
台式单柄双控洗面器水嘴



TLG08303B#PBR (抛光铜色)
TLG08303B (镀铬)
台式单柄双控洗面器水嘴
(附排水金具)

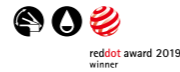

TBG08301BA#PBR (抛光铜色)
TBG08301BA (镀铬)

壁式单柄双控淋浴水嘴



TBG08302BA#PBR (抛光铜色)
TBG08302BA (镀铬)

壁式单柄双控浴缸水嘴



TBG08303BA#PBR (抛光铜色)
TBG08303BA (镀铬)
/TBN01001C

壁式单柄双控暗装
水嘴面板 / 阀体 (关闭切换)



TBG08304BA#PBR (抛光铜色)
TBG08304BA (镀铬)
/TBN01001C

壁式单柄双控暗装水嘴面板 / 阀体
(二种出水切换 / 关闭切换)



TLG08304B#PBR (抛光铜色)
TLG08304B (镀铬)
台式单柄双控洗面器水嘴



TLG08305B#PBR (抛光铜色)
TLG08305B (镀铬)
台式单柄双控洗面器水嘴
(附排水金具)



TLG08306B#PBR (抛光铜色)
TLG08306B (镀铬)
台式单柄双控洗面器水嘴



TBG08001B#PBR (抛光铜色)
TBG08001B (镀铬)

吐水口



TBG08201B#PBR (抛光铜色)
TBG08201B (镀铬)

台式双柄双控浴缸水嘴



TBG08305C#PBR (抛光铜色)
TBG08305C (镀铬)

台式单柄双控浴缸水嘴
(带手持花洒)



TBG08202C#PBR (抛光铜色)
TBG08202C (镀铬)

台式双柄双控浴缸水嘴
(带手持花洒)



TLG08307C#PBR (抛光铜色)
TLG08307C (镀铬)
/TLN033G0C

壁式单柄双控暗装水嘴 (短款)



TLG08308C#PBR (抛光铜色)
TLG08308C (镀铬)
/TLN033G0C

壁式单柄双控暗装水嘴 (长款)



TLG08201B#PBR (抛光铜色)
TLG08201B (镀铬)

台式双柄双控洗面器水嘴
(附排水金具)



TBG08306C#PBR (抛光铜色)
TBG08306C (镀铬)
/TBN01105B

立式单柄双控浴缸水嘴 / 阀体



镀铬

抛光铜色 # PBR

抛光玫瑰金 # PRG

GM series

reddot award 2019
winner

出水口与手柄采用
大胆的拱形设计，
与曲面反射交相辉映，
创造出令人印象深刻的空间。



以 独具特色的建筑所呈现的庄重、威严感作为设计
构思。

出水口与主体部都采用拱形构造，以鸟居为设计原型。
威严庄重的气质与金属的光泽感相互衬托，十分引人注目。



TLG09301B (镀铬)
台式单柄双控洗面器水嘴
(附排水金具)



TLG09302B (镀铬)
台式单柄双控洗面器水嘴



TLG09303B (镀铬)
台式单柄双控洗面器水嘴
(附排水金具)



TBG09301BA (镀铬)
壁式单柄双控淋浴水嘴



TBG09302BA (镀铬)
壁式单柄双控浴缸水嘴



TBG09303BA (镀铬)/TBN01001C
壁式单柄双控暗装水嘴面板 / 阀体
(开闭切换)



TBG09304BA (镀铬)/TBN01001C
壁式单柄双控暗装水嘴面板 / 阀体
(二种出水切换 / 开闭切换)



TLG09304B (镀铬)
台式单柄双控洗面器水嘴



TLG09305B (镀铬)
台式单柄双控洗面器水嘴
(附排水金具)



TLG09306B (镀铬)
台式单柄双控洗面器水嘴



TBG09001B (镀铬)
吐水口



TBG09201B (镀铬)
台式双柄双控浴缸水嘴



TBG09305C (镀铬)
台式单柄双控浴缸水嘴
(带手持花洒)



TBG09202C (镀铬)
台式双柄双控浴缸水嘴
(带手持花洒)



TLG09307C (镀铬)
/TLN023G0C

壁式单柄双控暗装水嘴 (短款)



TLG09308C (镀铬)
/TLN023G0C

壁式单柄双控暗装水嘴 (长款)



TLG09201BA (镀铬)

台式双柄双控洗面器水嘴
(附排水金具)



TBG09306C (镀铬)/TBN01105B

立式单柄双控浴缸水嘴 / 阀体



GT series



简约之中，尽显自然之美。
优雅的线条，契合大部分室内设计空间。

GT 系列采用精致设计，强调横竖线条，拥有更纤薄、更流畅的外形，尽显优雅气质。它能轻松地与多种室内设计风格以及多类洗面器形状相搭配。





TLG13301C#BGP (拉丝石墨灰)
TLG13301C (镀铬)

台式单柄双控洗面器水嘴
(附排水金具)



TLG13302C#BGP (拉丝石墨灰)
TLG13302C (镀铬)

台式单柄双控洗面器水嘴



TLG13303C#BGP (拉丝石墨灰)
TLG13303C (镀铬)

台式单柄双控洗面器水嘴
(附排水金具)



TBG13301C#BGP (拉丝石墨灰)
TBG13301C (镀铬)

壁式单柄双控淋浴水嘴



TBG13302C#BGP (拉丝石墨灰)
TBG13302C (镀铬)

壁式单柄双控浴缸水嘴



TBG13303C#BGP (拉丝石墨灰)
TBG13303C (镀铬)
/TBN01001C

壁式单柄双控暗装水嘴面板 / 阀体
(开闭切换)



TBG13304C#BGP (拉丝石墨灰)
TBG13304C (镀铬)
/TBN01001C

壁式单柄双控暗装水嘴面板 / 阀体
(二种出水切换 / 开闭切换)



TLG13304C#BGP (拉丝石墨灰)
TLG13304C (镀铬)

台式单柄双控洗面器水嘴



TLG13305C#BGP (拉丝石墨灰)
TLG13305C (镀铬)

台式双柄双控洗面器水嘴
(附排水金具)



TLG13306C#BGP (拉丝石墨灰)
TLG13306C (镀铬)

台式双柄双控洗面器水嘴

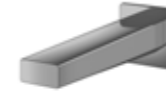

TBG10001B#BGP (拉丝石墨灰)
TBG10001B (镀铬)

吐水口



TBG13201C#BGP (拉丝石墨灰)
TBG13201C (镀铬)

台式单柄双控浴缸水嘴



TBG13305C#BGP (拉丝石墨灰)
TBG13305C (镀铬)

台式单柄双控浴缸水嘴
(带手持花洒)



TBG13202C#BGP (拉丝石墨灰)
TBG13202C (镀铬)

台式单柄双控浴缸水嘴
(带手持花洒)



TLG13307C#BGP (拉丝石墨灰)
TLG13307C (镀铬)
/TLN103G0C

壁式单柄双控暗装水嘴 (短款)



TLG13308C#BGP (拉丝石墨灰)
TLG13308C (镀铬)
/TLN103G0C

壁式单柄双控暗装水嘴 (长款)



TLG13201C#BGP (拉丝石墨灰)
TLG13201C (镀铬)

台式双柄双控洗面器水嘴
(附排水金具)



TBG13306C#BGP (拉丝石墨灰)
TBG13306C (镀铬)
/TBN01105B

立式单柄双控浴缸水嘴 / 阀体



镀铬



拉丝镍 #BN



抛光法兰金 #PFG



抛光铜色 #PBR



哑光黑 #MBL

*1 本商品包含一部分PVD涂层
*2 本商品是喷涂涂层
(非2022reddot获奖对象)



red dot winner 2022



抛光玫瑰金 #PRG



拉丝石墨灰 #BGP



拉丝钛灰 #BTN



拉丝铜色 #BBR

GB series



FAUCET



颇具格调的方形设计呈现出和谐的匀称感，R角边缘的弧形透出对细节的精致追求。整个造型让空间多了一份“凛然”的氛围。

R角边缘的弧形设计增添了些许柔和，让人不禁产生想要触摸的冲动。

R角边缘呈一直线的高光，与黑色的高级光泽感相映成趣。逐渐变细的出水口更加凸显出整体轮廓的独特感。





TLG10301B#MBL (哑光黑)
TLG10301B (镀铬)

台式单柄双控洗面器水嘴
(附排水金具)



reddot winner 2020



TLG10302B#MBL (哑光黑)
TLG10302B (镀铬)

台式单柄双控洗面器水嘴



reddot winner 2020



TLG10303B#MBL (哑光黑)
TLG10303B (镀铬)

台式单柄双控洗面器水嘴
(附排水金具)



reddot winner 2020



TBG10301BA#MBL (哑光黑)
TBG10301BA (镀铬)

壁式单柄双控淋浴水嘴



TBG10302BA#MBL (哑光黑)
TBG10302BA (镀铬)

壁式单柄双控浴缸水嘴



TBG10303BB#MBL (哑光黑)
TBG10303BA (镀铬)
/TBN01001C

壁式单柄双控暗装水嘴面板 / 阀体
(开闭切换)



TBG10304BB#MBL (哑光黑)
TBG10304BA (镀铬)
/TBN01001C

壁式单柄双控暗装水嘴面板 / 阀体
(二种出水切换 / 开闭切换)



TLG10304B#MBL (哑光黑)
TLG10304B (镀铬)

台式单柄双控洗面器水嘴



reddot winner 2020



TLG10305B#MBL (哑光黑)
TLG10305B (镀铬)

台式单柄双控洗面器水嘴
(附排水金具)



reddot winner 2020



TLG10306B#MBL (哑光黑)
TLG10306B (镀铬)

台式单柄双控洗面器水嘴



reddot winner 2020



TBG10001B#MBL (哑光黑)
TBG10001B (镀铬)

吐水口



TBG10201B#MBL (哑光黑)
TBG10201B (镀铬)

台式双柄双控浴缸水嘴



TBG10305CA#MBL (哑光黑)*1
TBG10305C (镀铬)

台式单柄双控浴缸水嘴
(带手持花洒)



TBG10202CA#MBL (哑光黑)*1
TBG10202C (镀铬)

台式双柄双控浴缸水嘴
(带手持花洒)



TLG10307C#MBL (哑光黑)
TLG10307C (镀铬)
/TLN023G0C
TLN023G0C#MBL

壁式单柄双控暗装水嘴 (短款)



TLG10308C#MBL (哑光黑)
TLG10308C (镀铬)
/TLN023G0C
TLN023G0C#MBL

壁式单柄双控暗装水嘴 (长款)



TLG10201BA#MBL (哑光黑)
TLG10201BA (镀铬)

台式双柄双控洗面器水嘴
(附排水金具)



TBG10306C#MBL (哑光黑)
TBG10306C (镀铬)
/TBN01105B

立式单柄双控浴缸水嘴 / 阀体



镀铬



哑光黑 #MBL

*1 本商品包含一部分PVD涂层

*2 本商品是喷涂涂层

(非2022reddot获奖对象)



reddot winner 2022



抛光玫瑰金 #PRG



拉丝石墨灰 #BGP



拉丝钛灰 #BTN

GA series  red dot award 2018
winner

柔和的曲线和硬朗的线条形成巧妙的平衡。
经典的高雅设计提升每一天的生活品质。

出 水口和手柄处的曲线优美柔和，而边缘处的线条
又透着硬朗鲜明。
外形设计简洁沉静，营造出精致优雅的氛围。





TLG04301B#MBL (哑光黑)
TLG04301B (镀铬)

台式单柄双控洗面器水嘴
(附排水金具)



TLG04303B#MBL (哑光黑)
TLG04303B (镀铬)

台式单柄双控洗面器水嘴



TLG04304B#MBL (哑光黑)
TLG04304B (镀铬)

台式单柄双控洗面器水嘴
(附排水金具)



TLG04306B#MBL (哑光黑)
TLG04306B (镀铬)

台式单柄双控洗面器水嘴



TBG04301BA#MBL (哑光黑)
TBG04301BA (镀铬)

壁式单柄双控淋浴水嘴



TBG04302BA#MBL (哑光黑)
TBG04302BA (镀铬)

壁式单柄双控浴缸水嘴



TBG04303BB#MBL (哑光黑)
TBG04303BA (镀铬)
/TBN01001C

壁式单柄双控暗装水嘴面板 / 阀体
(开闭切换)



TLG04307B#MBL (哑光黑)
TLG04307B (镀铬)

台式单柄双控洗面器水嘴
(附排水金具)



TLG04308B#MBL (哑光黑)
TLG04308B (镀铬)

台式单柄双控洗面器水嘴



TLG04309C#MBL (哑光黑)
TLG04309C (镀铬)
/TLN023G0C
TLN023G0C#MBL

壁式单柄双控暗装洗面器水嘴(短款)



TLG04310C#MBL (哑光黑)
TLG04310C (镀铬)
/TLN023G0C
TLN023G0C#MBL

壁式单柄双控暗装洗面器水嘴(长款)



TBG04304BA#MBL (哑光黑)
TBG04304BA (镀铬)
/TBN01001C

壁式单柄双控暗装水嘴面板 / 阀体
(二种出水切换, 开闭切换)



TBG02001B#MBL (哑光黑)
TBG02001B (镀铬)

吐水口



TBG04201BA#MBL (哑光黑)
TBG04201BA (镀铬)

台式双柄双控浴缸水嘴



TLG04201BB#MBL (哑光黑)
TLG04201BB (镀铬)

台式双柄双控洗面器水嘴
(附排水金具)



TLG04101B#MBL (哑光黑)
TLG04101B (镀铬)

台式单柄单控洗面器水嘴



TBG04202BC#MBL (哑光黑)*1
TBG04202BB (镀铬)

台式双柄双控浴缸水嘴
(带手持花洒)



TRG04301B#MBL (哑光黑)
TRG04301B (镀铬)

台式单柄双控净身器水嘴
(附排水金具)



*1 本商品包含一部分PVD涂层
*2 本商品是喷涂涂层
(非2022reddot获奖对象)

相同的颜色名称, 根据商品材料和材质的不同, 颜色也可能存在差异。

GF series



采用简洁、匀称的圆柱形造型。
细节处的精巧工艺展现奢华与高级质感。



简约的外形使接缝、间隙处的精致工艺一览无余。

手柄顶部采用独特的纹理加工工艺，凸显高品位、实现舒适的触感。

以玫瑰金色为基调，手柄处采用拉丝工艺，主体部经过抛光处理，在同色系中呈现出不同质感的鲜明对比。





TLG11301B (镀铬)
TLG11301B#MBL (哑光黑)

台式单柄双控洗面器水嘴
(附排水金具)



reddot winner 2020



TLG11302B (镀铬)
TLG11302B#MBL (哑光黑)

台式单柄双控洗面器水嘴



reddot winner 2020



TLG11303B (镀铬)
TLG11303B#MBL (哑光黑)

台式单柄双控洗面器水嘴
(附排水金具)



reddot winner 2020



TLG11304B (镀铬)
TLG11304B#MBL (哑光黑)

台式单柄双控洗面器水嘴



reddot winner 2020



TLG11305B (镀铬)
TLG11305B#MBL (哑光黑)

台式单柄双控洗面器水嘴
(附排水金具)



reddot winner 2020



TLG11306B (镀铬)
TLG11306B#MBL (哑光黑)

台式单柄双控洗面器水嘴



reddot winner 2020



TLG11307C (镀铬)
TLG11307C#MBL (哑光黑)
/TLN023G0C
TLN023G0C#MBL

壁式单柄双控暗装水嘴 (短款)



TLG11308C (镀铬)
TLG11308C#MBL (哑光黑)
/TLN023G0C
TLN023G0C#MBL

壁式单柄双控暗装水嘴 (长款)



TLG11201B (镀铬)
TLG11201B#MBL (哑光黑)

台式双柄双控洗面器水嘴
(附排水金具)



TBG11301BA (镀铬)
TBG11301BA#MBL (哑光黑)

壁式单柄双控淋浴水嘴



TBG11302BA (镀铬)
TBG11302BA#MBL (哑光黑)

壁式单柄双控浴缸水嘴



TBG11303BA (镀铬)
TBG11303BB#MBL (哑光黑)
/TBN01001C

壁式单柄双控
暗装水嘴面板 / 阀体
(开闭切换)



TBG11304BA (镀铬)
TBG11304BB#MBL (哑光黑)
/TBN01001C

壁式单柄双控
暗装水嘴面板 / 阀体
(二种出水切换 / 开闭切换)



TBG11001B (镀铬)
TBG11001B#MBL (哑光黑)

吐水口



TBG11201B (镀铬)
TBG11201B#MBL (哑光黑)

台式双柄双控浴缸水嘴



TBG11305C (镀铬)
TBG11305CA#MBL (哑光黑) *1

台式单柄双控浴缸水嘴
(带手持花洒)



TBG11202C (镀铬)
TBG11202CA#MBL (哑光黑) *1

台式双柄双控浴缸水嘴
(带手持花洒)



TBG11306C (镀铬)
TBG11306C#MBL (哑光黑)
/TBN01005B

立式单柄双控浴缸水嘴 / 阀体



镀铬

哑光黑 # MBL



reddot winner 2022

抛光玫瑰金 # PRG

拉丝石墨灰 # BGP

拉丝钛灰 # BTN

GS series



reddot award 2018
winner



质朴自然的外形轮廓，
绝妙的搭配蕴藏着浑然天成的摩登感。

平滑的线条勾勒出简单时尚的造型，沉稳而大方。
无论从视觉上还是触觉上都给人以柔和的印象，经典设计、时尚永恒。
同时在颜色及外形上也增加了更多的选择，令人耳目一新。





TLG03301B#MBL (哑光黑)
TLG03301B (镀铬)

台式单柄双控洗面器水嘴
(附排水金具)



TLG03302B#MBL (哑光黑)
TLG03302B (镀铬)

台式单柄双控洗面器水嘴



TLG03303B#MBL (哑光黑)
TLG03303B (镀铬)

台式单柄双控洗面器水嘴
(附排水金具)



TBG03301BA#MBL (哑光黑)
TBG03301BA (镀铬)

壁式单柄双控淋浴水嘴



TBG03302BA#MBL (哑光黑)
TBG03302BA (镀铬)

壁式单柄双控浴缸水嘴



TBG03303BB#MBL (哑光黑)
TBG03303BA (镀铬)
/TBN01001C

壁式单柄双控暗装水嘴面板 / 阀体
(开闭切换)



TLG03304B#MBL (哑光黑)
TLG03304B (镀铬)

台式单柄双控洗面器水嘴



TLG03305B#MBL (哑光黑)
TLG03305B (镀铬)

台式单柄双控洗面器水嘴
(附排水金具)

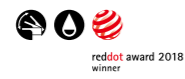

TLG03306B#MBL (哑光黑)
TLG03306B (镀铬)

台式单柄双控洗面器水嘴

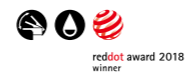

TBG03304BB#MBL (哑光黑)
TBG03304BA (镀铬)
/TBN01001C

壁式单柄双控暗装水嘴面板 / 阀体
(二种出水切换, 开闭切换)



TBG01001B#MBL (哑光黑)
TBG01001B (镀铬)

吐水口



TBG03201BA#MBL (哑光黑)
TBG03201BA (镀铬)

台式双柄双控浴缸水嘴



TLG03307C#MBL (哑光黑)
TLG03307C (镀铬)
/TLN023G0C
TLN023G0C#MBL

壁式单柄双控暗装洗面器水嘴 (短款)



TLG03308C#MBL (哑光黑)
TLG03308C (镀铬)
/TLN023G0C
TLN023G0C#MBL

壁式单柄双控暗装洗面器水嘴 (长款)



TLG03201BB#MBL (哑光黑)
TLG03201BB (镀铬)

台式双柄双控洗面器水嘴
(附排水金具)



TBG03202BC#MBL (哑光黑)*1
TBG03202BB (镀铬)

台式双柄双控浴缸水嘴
(带手持花洒)



GO series

设计灵感来自于自然的植物外形，
尽显优雅挺拔。



出水口圆润饱满、手柄呈现
出 略带向上翘曲的设计，主
体部的曲线纤细自然。

犹如沐浴着阳光不断生长的植物，
给您带去一份活力、为空间增添一
丝生气。



TLG01301B (镀铬)
台式单柄双控洗面器水嘴
(附排水金具)



TLG01303B (镀铬)
台式单柄双控洗面器水嘴



TLG01304B (镀铬)
台式单柄双控洗面器水嘴
(附排水金具)



TLG01306B (镀铬)
台式单柄双控洗面器水嘴



TBG01301BA (镀铬)
壁式单柄双控淋浴水嘴



TBG01302BA (镀铬)
壁式单柄双控浴缸水嘴



TBG01303BA (镀铬)/TBN01001C
壁式单柄双控暗装水嘴面板 / 阀体
(开闭切换)



TBG01304BA (镀铬)/TBN01001C
壁式单柄双控暗装水嘴面板 / 阀体
(二种出水切换, 开闭切换)



TLG01307B (镀铬)
台式单柄双控洗面器水嘴
(附排水金具)



TLG01308B (镀铬)
台式单柄双控洗面器水嘴



TLG01309BB (镀铬)
台式单柄双控洗面器水嘴
(附排水金具)



TLG01310C (镀铬)
/TLN023G0C
壁式单柄双控暗装洗面器水嘴 (短款)



TBG01001B (镀铬)
吐水口



TBG01201BA (镀铬)
台式双柄双控浴缸水嘴



TBG01305C (镀铬)
台式单柄双控浴缸水嘴
(带手持花洒)



TBG01202BB (镀铬)
台式双柄双控浴缸水嘴
(带手持花洒)



TLG01311C (镀铬)
/TLN023G0C
壁式单柄双控暗装洗面器水嘴 (长款)



TLG01201BB (镀铬)
台式双柄双控洗面器水嘴
(附排水金具)



TBG01306C (镀铬)/TBN01105B
立式单柄双控浴缸水嘴 / 阀体



GR series

外形如同
水平垂直切割而成的金属。
厚重的存在感和凝重感，
使空间更加华丽有品位。

边 缘线条光亮锐利，出水口及手柄的外形呈现轻微的弧度。
这种独具匠心的设计营造出典雅的氛围，让人充分领略到庄重的造型美。



TLG02301B#BN (拉丝镀铬)
TLG02301B (镀铬)

台式单柄双控洗面器水嘴
(附排水金具)



TLG02303B#BN (拉丝镀铬)
TLG02303B (镀铬)

台式单柄双控洗面器水嘴



TLG02304B#BN (拉丝镀铬)
TLG02304B (镀铬)

台式单柄双控洗面器水嘴
(附排水金具)



TLG02306B#BN (拉丝镀铬)
TLG02306B (镀铬)

台式单柄双控洗面器水嘴



TBG02301BA#BN (拉丝镀铬)
TBG02301BA (镀铬)

壁式单柄双控淋浴水嘴



TBG02302BA#BN (拉丝镀铬)
TBG02302BA (镀铬)

壁式单柄双控浴缸水嘴



TBG02303BA#BN (拉丝镀铬)
TBG02303BA (镀铬)
/TBN01001C

壁式单柄双控暗装
水嘴面板 / 阀体 (开闭切换)



TBG02304BA#BN (拉丝镀铬)
TBG02304BA (镀铬)
/TBN01001C

壁式单柄双控暗装
水嘴面板 / 阀体 (二种出水切换, 开闭切换)



TLG02307B#BN (拉丝镀铬)
TLG02307B (镀铬)

台式单柄双控洗面器水嘴
(附排水金具)



TLG02308B#BN (拉丝镀铬)
TLG02308B (镀铬)

台式单柄双控洗面器水嘴



TLG02309BB#BN (拉丝镀铬)
TLG02309BB (镀铬)

台式单柄双控洗面器水嘴
(附排水金具)



TLG02310C#BN (拉丝镀铬)
TLG02310C (镀铬)
/TLN023G0C
TLN023G0C#BN

壁式单柄双控暗装洗面器水嘴 (短款)



TBG02001B#BN (拉丝镀铬)
TBG02001B (镀铬)

吐水口



TBG02201BA#BN (拉丝镀铬)
TBG02201BA (镀铬)

台式双柄双控浴缸水嘴



TBG02305C#BN (拉丝镀铬)
TBG02305C (镀铬)

台式单柄双控浴缸水嘴
(带手持花洒)



TBG02202BB#BN (拉丝镀铬)
TBG02202BB (镀铬)

台式双柄双控浴缸水嘴
(带手持花洒)



TLG02311C#BN (拉丝镀铬)
TLG02311C (镀铬)
/TLN023G0C
TLN023G0C#BN

壁式单柄双控暗装洗面器水嘴 (长款)



TLG02201BB#BN (拉丝镀铬)
TLG02201BB (镀铬)

台式双柄双控洗面器水嘴
(附排水金具)



TBG02306C#BN (拉丝镀铬) / TBN01105B
TBG02306C (镀铬)

立式单柄双控浴缸水嘴 / 阀体



镀铬



拉丝镀铬 #BN



哑光黑 #MBL

*1 本商品包含一部分PVD涂层
*2 本商品是喷涂涂层
(非2022reddot获奖对象)



reddot winner 2022



拉丝铜色 #BBR



端庄的直线与柔和的曲线相互交融，
缔造当代美学。

[LH 系列]



TLS06301C

台式单柄双控洗面器水嘴
(附排水金具)



TLS06302C

台式单柄双控洗面器水嘴



TLS06303C

台式单柄双控洗面器水嘴
(附排水金具)



TLS06304C

台式单柄双控洗面器水嘴



TLS06305C

台式单柄双控洗面器水嘴
(附排水金具)



TLS06306C

台式单柄双控洗面器水嘴



TLS06307C/TLN113G0C

壁式单柄双控暗装洗面器水嘴



TLS06308C/TLN113G0C

壁式单柄双控暗装洗面器水嘴



TBS06301C

壁式单柄双控淋浴水嘴



TBS06302C

壁式单柄双控浴缸水嘴



TBS06303C/TBN103C0C

壁式单柄双控暗装
水嘴面板 / 阀体
(开闭切换)



TBS06304C/TBN103D0C

壁式单柄双控暗装
水嘴面板 / 阀体
(二种出水切换 / 开闭切换)



































领略简约，360 度美感。

追求圆筒的组合之美。

由各种不同的圆筒状和平滑曲面构成。
通过有机的造型，创造出俊秀表情。
请享受，这简约空间的每一天。

[LB 系列]

| | | | | |
|---|---|---|---|---|
|  |  |  |  |  |
| TLS01301B 台式单柄双控洗面器水嘴 (附排水金具) | TLS01303B 台式单柄双控洗面器水嘴 | TLS01304B 台式单柄双控洗面器水嘴 (附排水金具) | TLS01306B 台式单柄双控洗面器水嘴 | TLS01307B 台式单柄双控洗面器水嘴 (附排水金具) |
|  |  |  |  |  |
|  |  |  |  |  |
| TLS01308B 台式单柄双控洗面器水嘴 | TLS01309C /TLN113G0C 壁式单柄双控暗装洗面器水嘴 | TLS01310C /TLN113G0C 壁式单柄双控暗装洗面器水嘴 | TLS01201BA 台式双柄双控洗面器水嘴 (附排水金具) | TLS01101B 台式单柄单控洗面器水嘴 |
|  |  |  |  |  |
|  |  |  |  |  |
| TBS01301B 壁式单柄双控淋浴水嘴 | TBS01302B 壁式单柄双控浴缸水嘴 | TBS01303C /TBN103C0C 壁式单柄双控暗装 水嘴面板 / 阀体 (开闭切换) | TBS01304C /TBN103D0C 壁式单柄双控暗装 水嘴面板 / 阀体 (二种出水切换, 开闭切换) | TBG01001B 吐水口 |
|  |  |  |  |  |
|  |  | | | |
| TBS01201BA 台式双柄双控浴缸水嘴 | TBS01202C 台式双柄双控浴缸水嘴 (带手持花洒) | | | |



新的经典，品味高雅时间。

摩登中融合经典。

在现代的印象中，融入了古雅的趣味。
兼容两种不同表情的商品，满足当代审美。
简约，古典，高雅，点缀你的每一天。

[LN 系列]

| | | | | |
|---|---|---|---|---|
|  |  |  |  |  |
| TLS02301B 台式单柄双控洗面器水嘴 (附排水金具) | TLS02302B 台式单柄双控洗面器水嘴 | TLS02303B 台式单柄双控洗面器水嘴 (附排水金具) | TLS02304B 台式单柄双控洗面器水嘴 | TLS02305B 台式单柄双控洗面器水嘴 (附排水金具) |
|  |  |  |  | |
| TLS02306B 台式单柄双控洗面器水嘴 | TLS02307C / TLN113G0C 壁式单柄双控暗装洗面器水嘴 | TLS02308C / TLN113G0C 壁式单柄双控暗装洗面器水嘴 | TLS02201BA 台式双柄双控洗面器水嘴 (附排水金具) | |
|  |  |  |  |  |
| TBS02301B 壁式单柄双控淋浴水嘴 | TBS02302B 壁式单柄双控浴缸水嘴 | TBS02303C / TBN103C0C 壁式单柄双控暗装 水嘴面板 / 阀体 (开闭切换) | TBS02304C / TBN10300C 壁式单柄双控暗装 水嘴面板 / 阀体 (二种出水切换, 开闭切换) | TBS02001B 吐水口 |
|  | |  | | |
| TBS02201BA 台式双柄双控浴缸水嘴 | | TBS02202C 台式双柄双控浴缸水嘴 (带手持花洒) | | |



曲面之美，见即惊叹。

细品而不厌，让人欣喜的设计。

圆滑外型，品质感出色的立体曲面设计。
像海边玻璃石般光滑的曲线，每一次触碰，都能带来欣喜。
融入你的生活。

[LC 系列]



TLS03301B
台式单柄双控洗面器水嘴
(附排水金具)



TLS03302B
台式单柄双控洗面器水嘴



TLS03303B
台式单柄双控洗面器水嘴
(附排水金具)



TLS03304B
台式单柄双控洗面器水嘴



TLS03305B
台式单柄双控洗面器水嘴
(附排水金具)



TLS03306B
台式单柄双控洗面器水嘴



TLS03307C
/TLN113G0C
壁式单柄双控暗装洗面器水嘴
※无排水金具式样



TLS03308C
/TLN113G0C
壁式单柄双控暗装洗面器水嘴
※无排水金具式样



TBS03301B
壁式单柄双控淋浴水嘴



TBS03302B
壁式单柄双控浴缸水嘴



TBS03303C
/TBN103C0C
壁式单柄双控暗装
水嘴面板 / 阀体
(开闭切换)



TBS03304C
/TBN103D0C
壁式单柄双控暗装
水嘴面板 / 阀体
(二种出水切换, 开闭切换)



TBS03001B
吐水口

























休闲轻松，丰富多彩的每一天。

小巧玲珑，却充满张力。







方便日常使用而设计的休闲款。
即使在紧凑的梳洗空间也能契合其中，
灵巧与张力兼容，释放出独特的存在感。
就像一套自己心仪的餐具，给你日常的每天带来一份姿彩。





[LF 系列]

| | | | | |
|---|---|---|---|---|
|  |  |  |  |  |
| TLS04301B 台式单柄双控洗面器水嘴 (附排水金具) | TLS04303B 台式单柄双控洗面器水嘴 | TLS04304B 台式单柄双控洗面器水嘴 (附排水金具) | TLS04305B 台式单柄双控洗面器水嘴 | TLS04306B 台式单柄双控洗面器水嘴 (附排水金具) |
|  |  |  |  |  |
|  |  |  |  |  |
| TLS04307B 台式单柄双控洗面器水嘴 | TLS04308C /TLN113G0C 壁式单柄双控暗装洗面器水嘴 ※无排水金具式样 | TLS04309C /TLN113G0C 壁式单柄双控暗装洗面器水嘴 ※无排水金具式样 | TBS04301B 壁式单柄双控淋浴水嘴 | TBS04302B 壁式单柄双控浴缸水嘴 |
|  |  |  | | |
|  |  |  |  | |
| TBS04303C /TBN103C0C 壁式单柄双控 暗装水嘴面板 / 阀体 (开闭切换) | TBS04304C /TBN103D0C 壁式单柄双控 暗装水嘴面板 / 阀体 (二种出水切换, 开闭切换) | TBS03001B 吐水口 | TRS04301B 台式单柄双控净身器水嘴 (附排水金具) | |
| | | |  | |

COLOR VARIATION | 多彩选择

● : 标准商品
○ : 定制生产商品 (预计交货期请咨询门店销售顾问)

| | | Cr | BN | PFG | PBR | BBR | PRG |
|--------|-------|---|---|---|--|---|---|
| | |  |  |  |  |  |  |
| Z 系列龙头 | ZA 系列 | ● | ○ | ○ | ○ | - | ○ |
| | ZL 系列 | ● | - | - | - | - | - |
| G 系列龙头 | GE 系列 | ● | ○ TLG07303B *1 TBG07306C *1 | ○ | - | - | - |
| | GC 系列 | ● | - | - | ○ | - | ○ |
| | GM 系列 | ● | - | - | - | - | - |
| | GT 系列 | ● | ○ | ○ | ○ | ○ | ○ |
| | GB 系列 | ● | - | - | - | - | ○ |
| | GA 系列 | ● | ○ | - | - | - | - |
| | GF 系列 | ● | - | - | - | - | ○ |
| | GS 系列 | ● | - | - | - | - | - |
| | GO 系列 | ● | - | - | - | - | - |
| | GR 系列 | ● | ○ | - | - | ○ | - |

| MBL | BGP | BTN | Cr×BN |
|--|---|---|---|
|  <small>redot winner 2022 哑光黑 (#MBL)</small> |  |  |  |
| - | - | - | ○ |
| - | - | - | - |
| - | - | - | - |
| - | - | - | - |
| ○ TLG13301C *1 TLG13303C *1 TLG13305C *1 TLG13308C *1 | ○ TLG13301C *1 TLG13303C *1 TLG13305C *1 TLG13308C *1 | ○ TLG13301C *1 TLG13303C *1 TLG13305C *1 TLG13308C *1 | - |
| ○ TLG10303B *1 TLG10305B *1 TLG10301B *1 TLG10308BB *1 TBG10304BB *1 TBG10202CA *1 TBG10306C *1 | ○ | ○ | - |
| ○ TLG04307B *1 TLG04303B *1 TLG04301B *1 TLG04310BB *1 TBG04304BB *1 TBG04302BA *1 TBG04202BC *1 | ○ | ○ | - |
| ○ | ○ | ○ | - |
| ○ | - | - | - |
| - | - | - | - |
| ○ TLG02301B *1 | - | - | - |

*1 该型号为标准商品
*2 该型号为定制生产商品 (预计交货期请咨询门店销售顾问)



SHOWER



沉稳而又精致，
低调内敛的黑色光泽，历久弥新。
打造出充满质感的魅力空间。

Calm and delicate,
the surface will remain beautiful
indefinitely from Matte Black,
creating a charming space.



Relaxing

放 松

温暖的水流包裹身体
有助于舒缓压力和疲劳
让你慢慢地放松

Relaxing

放 松

从肩部展开

被温柔所环抱

身心舒缓放松起来

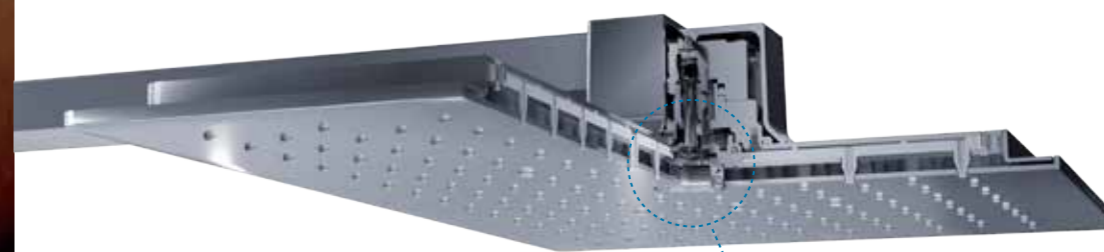

埋墙式花洒
(Z系列)

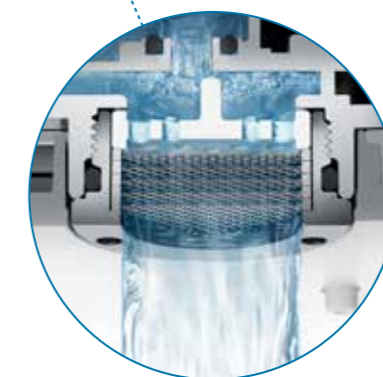

手持花洒
(G系列)

雨温

WARM SPA

 温暖水柱淋浴技术

温暖水柱包裹您的身体

放松身心

惬意休憩

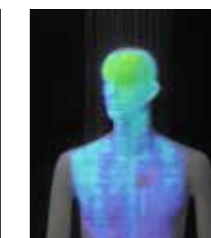
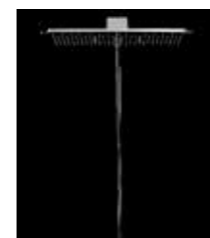

温暖水柱淋浴技术

TOTO普通产品

控制水流

采用独特的内部结构，水流不紊乱，使淋浴更加顺畅。

保证水温不流失

舒缓出水意味着减少热损失，让你被温暖的水流环绕，更有效地让全身迅速变暖。

水旋

GYROSTREAM

 水流旋转式淋浴技术

快速旋转的漩涡状水流，

清洁并按摩您的身体



Refreshing

激 活

充沛的水流

放松身心

活力唤醒，开启全新的一天



Refreshing

激活

在舒缓而温暖的水流里
沉静于自我世界中
将疲惫与烦恼带走
焕新身心
回归原本的自己



雨幻
COMFORT WAVE

  充沛水流淋浴技术

充沛的大颗粒水珠，放松身心，带来奢华冲淋感受。

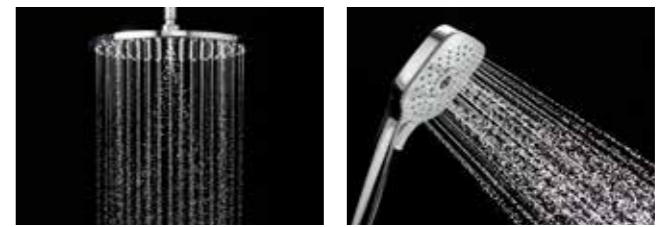

TOTO 的先进技术

本图形象展现了水流渗透情况。TOTO普通花洒喷出的水珠只是从头发上溅落，而充沛水流淋浴技术的大颗粒水珠可以直达头皮。

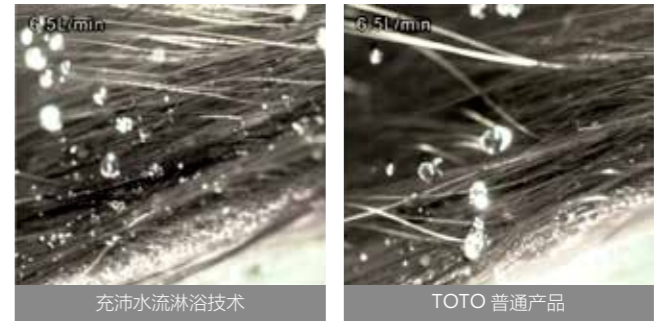

雨沁雾

MIST SPRAY SHOWER

 清洁水雾淋浴技术

细微气泡温柔接触肌肤。
好似披着薄雾的面纱，
还原真实的自我。

含有超细气泡的喷雾温和清洁肌肤

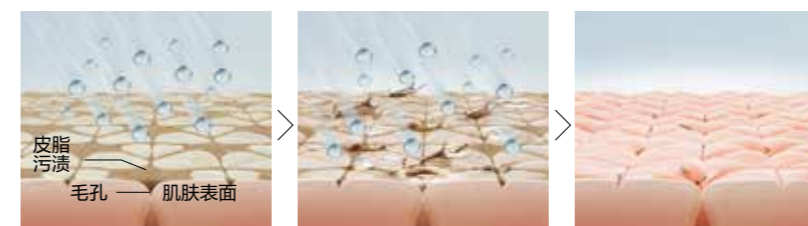

喷雾中含有细微气泡，
温和清洁肌肤

什么是细微气泡？

小于 $1\mu\text{m}$ 的气泡
(清洁水雾淋浴技术中UFB的尺寸和含量)
UFB直径: 约 $0.11\mu\text{m}$
UFB含量: 平均约1880万个/ml

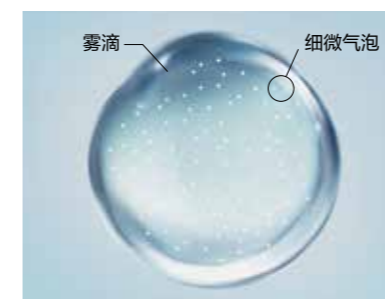

Revitalizing

焕发

就像渗透到身体深层的按摩
舒缓疲惫的肌肉，修复你的身体
激活能量，迎接下一个挑战

Revitalizing

焕发

恰到好处的刺激使身心得到解脱

激发出全身活力

使之神清气爽



激发活力
唤醒感官



手持花洒
(G系列)

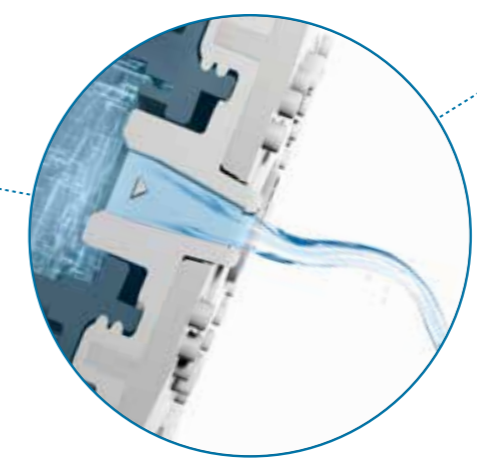

手持花洒
(L系列)



雨醒

ACTIVE WAVE

 动能水珠淋浴技术



雨跃

INTENSE WAVE

 劲醒水流淋浴技术



雨跃

INTENSE WAVE+

 劲醒水流淋浴技术 +



TOTO 的先进技术

水流大小示意比较，我们用透明水池演示水流强度

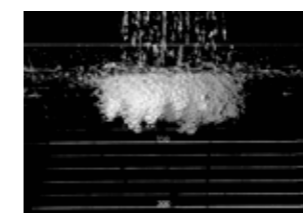

TOTO 普通产品



动能水珠淋浴技术



劲醒水流淋浴技术



劲醒水流淋浴技术 +



淋浴柱



镀铬 × 白色
TBW08407C



置物板视图



镀铬 × 黑色
TBW08408C



置物板视图



拉丝镀铬 × 白色
TBW08407C#BN



置物板视图



造型、质感、淋浴体验，
尽善尽美的追求，
让您在卫浴空间里尽享酣畅淋漓的淋浴。

不锈钢材质的控制面板拥有丰富的颜色和不同的工艺，
可搭配大理石纹样的置物板。

精致的细节设计凸显出Z系列的高级质感，提升了淋浴
空间的整体格调。

配有可用于收纳的置物板、以及水流可包裹全身的顶置
花洒，为您的淋浴带来更多的惬意和享受。

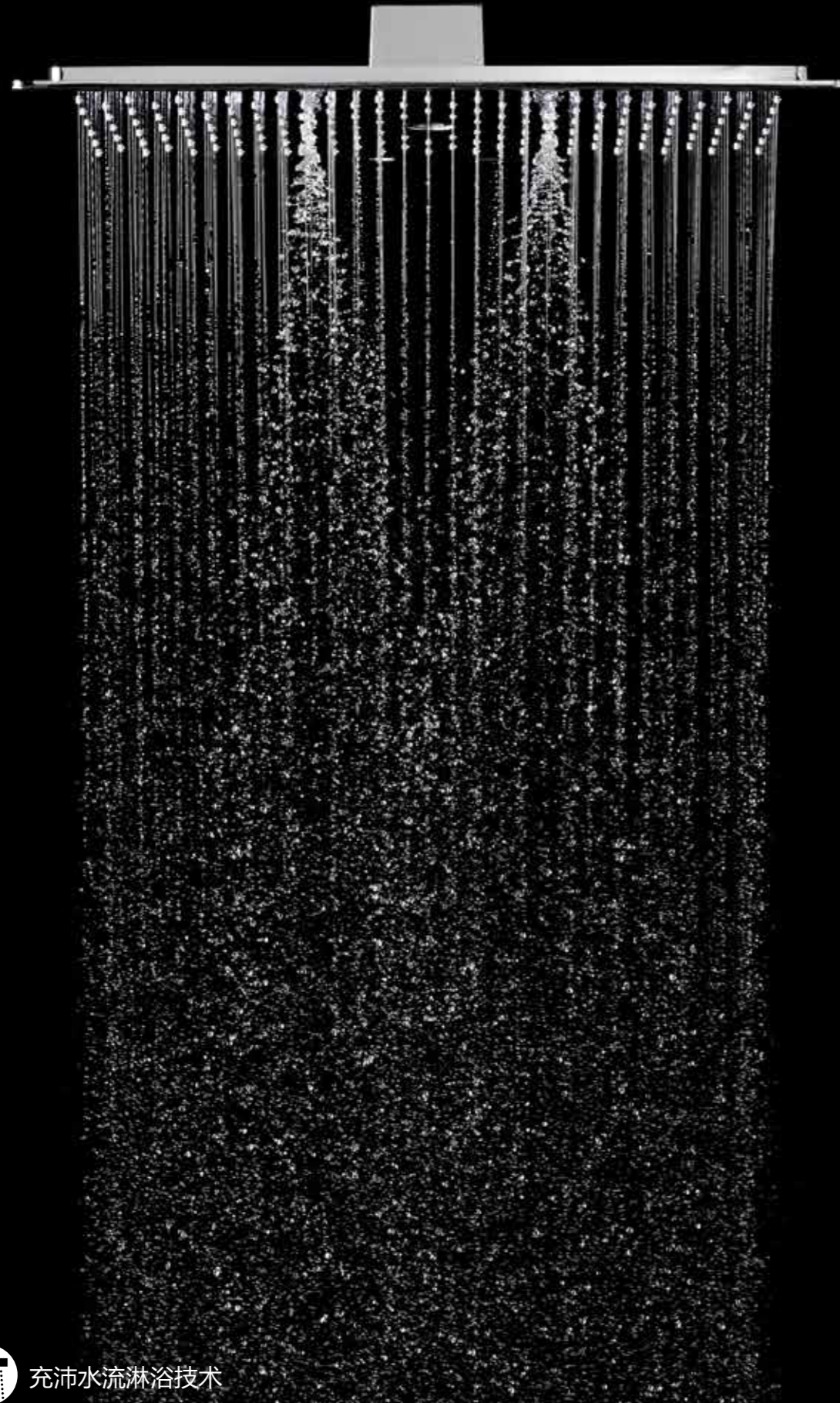

埋墙式花洒

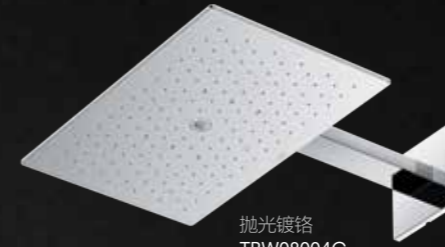

抛光镀铬
TBW08004C
哑光黑 #MBL
TBW08004C#MBL*1



抛光镀铬
TBW07004C
哑光黑 #MBL
TBW07004C#MBL*2

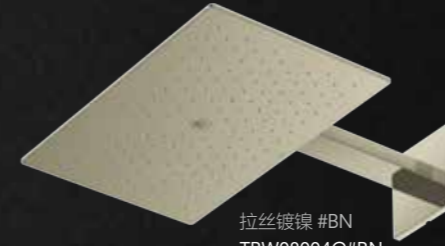

拉丝镍 #BN
TBW08004C#BN



抛光法兰金 #PFG
TBW07004C#PFG

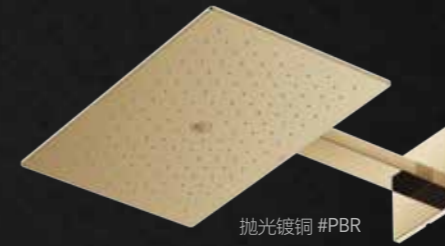

抛光镀铜 #PBR
TBW08004C#PBR



抛光镀铜 #PBR
TBW07004C#PBR

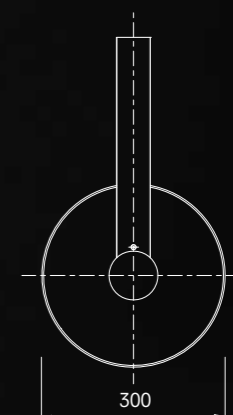
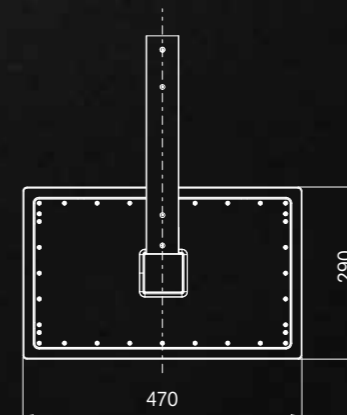

*1 本商品包含一部分PVD涂层
*2 本商品是喷涂涂层
(非2022reddot获奖对象)

相同的颜色名称，根据商品材料和材质的不同，颜色也可能存在差异。

直观的操作，
轻松调节自己喜欢的出水方式。

手持花洒，设计了拇指就可轻松操作的按键。只需轻按按键，就可以切换出水方式。
可自由切换的出水方式，给您带来舒适的淋浴享受。

手持花洒



温暖水柱淋浴技术



清洁水雾淋浴技术



充沛水流淋浴技术



只需点击按钮即可轻松切换出水

通过与温暖水柱淋浴技术的协作，提高清洁能力。在温暖水柱淋浴技术温暖身体后，清洁水雾淋浴技术的效果会更好

肌肤表面的污垢去除状态



默认



清洁水雾淋浴技术
* 温暖水柱淋浴技术



【测试条件】

出水量（清洁水雾淋浴技术）3.5升/分钟

出水时间：10秒

出水温度：42±1℃ N=10

*将1 μ l由疑似皮脂和炭黑混合而成的模拟污垢状涂在前额上，在上述测试条件下冲洗后，测定疑似皮脂去除率。

TOTO调查。

*在温暖水柱淋浴技术（8.3 L/min）中沐浴10分钟。

*效果因使用环境和个人而异。

埋墙式花洒

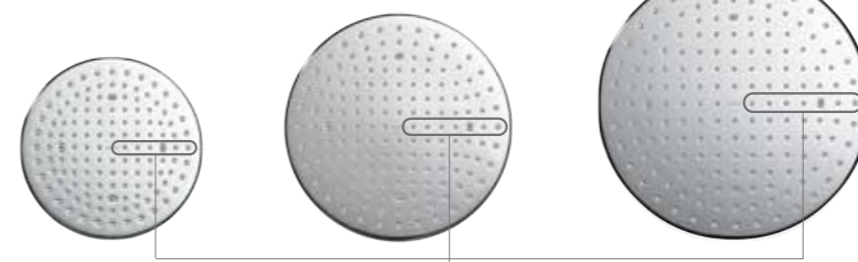

圆形：200/250/300mm

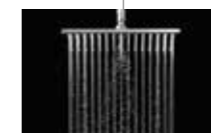

充沛水流淋浴技术

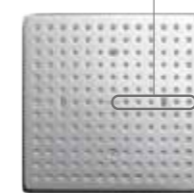

方形：200/250/300mm

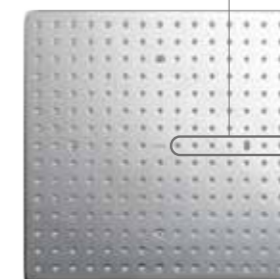
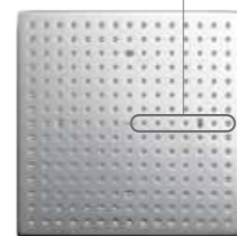

身体花洒



水流旋转式淋浴技术



手持花洒



方形：110mm

圆形：110mm



动能水珠淋浴技术



温暖水柱淋浴技术

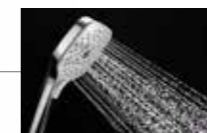

充沛水流淋浴技术

一键转换



直观的操作，
轻松调节自己喜欢的出水方式。

手持花洒，设计了大拇指就可轻松操作的扳手。只需左右扳动扳手，就可以切换出水方式。
可自由切换的出水方式，给您带来舒适的淋浴享受。

手持花洒



手持花洒



TOTO'S ADVANCED TECHNOLOGIES | TOTO 的先进技术

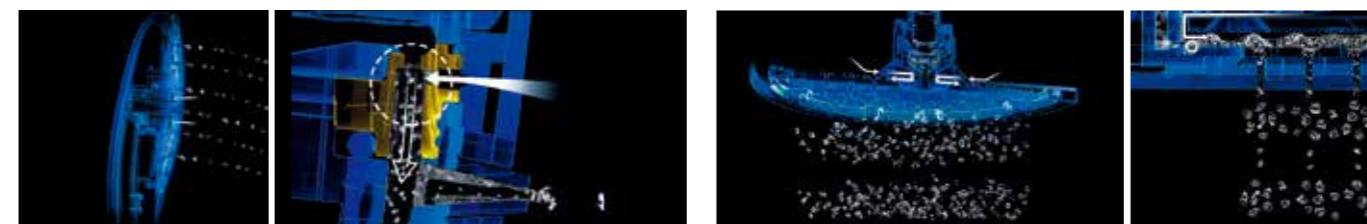

AERIAL SHOWER

手持花洒气泡吐水技术

应用于手持花洒上的气泡吐水技术，将空气注入水流中。富含丰富气泡的水流，激发您肌肤的活力，带来舒适淋浴体验。

AERIAL PULSE

空气按摩式出水技术

注满空气的水流，被激撞成无数个丰盈充沛的水泡，伴随着脉动按摩的强弱律动，轻柔的刺激您身体的各个部位，给您带来超凡舒适体验。



为了家人的安心使用

当小孩独自入浴时，您会担心热水温度的突然上升或者水嘴表面温度过高等危险状况的发生。TOTO 贴心的安全功能消除您的不安。



防止温度快速上升，以确保更安全的沐浴

形状记忆合金制成的线圈（SMA线圈）会立即对水温变化做出反应，抑制水温波动。

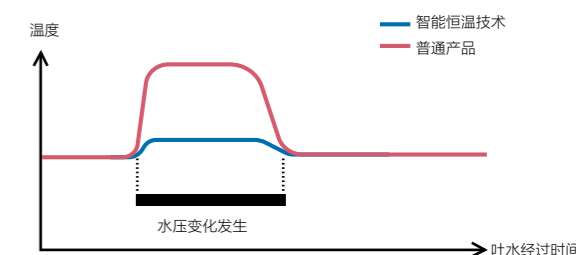

与TOTO普通水嘴相比，具有安全功能的恒温水嘴，即使在便器冲洗等因素造成水压降低的情况下，水温变化幅度依然较小。

智能恒温技术产品

淋浴柱

外露式自动温度调节器



TBW08405C
TBW08405C#MBL*1



TBW07404C



TBW01401C
TBW01401C#MBL*1



TBW07411C



TBV01401BA
TBV01401BA#MBL



TBV01402BA
TBV01402BA#MBL



*1 本商品包含一部分PVD涂层
*2 本商品是喷涂涂层
(非2022reddot获奖对象)

相同的颜色名称，根据商品材料和材质的不同，颜色也可能存在差异。

安心触 HEAT PROTECT



集安全与美观于一身 贴心淋浴保护

水嘴防烫保护技术通过内部巧妙的设计，用冷水包裹热水经过之处，即使碰到也不会有烫伤的危险。





G系列
TBW15AB0C
TBW15AB0C#MBL*1

埋墙式花洒 (单模式)
400*220mm



G系列
TBW15CB0C
TBW15CB0C#MBL*1
/TBN01002C

埋墙式花洒 (双模式)
400*220mm



G系列
TBW15EB0C
TBW15EB0C#MBL*1
/TBN01003C

埋墙式花洒 (三模式)
400*220mm



reddot winner 2026



G系列
TBW08001C
TBW08001C#MBL*1

埋墙式花洒 (单模式)
200*200mm



G系列
TBW08002C
TBW08002C#MBL*1

埋墙式花洒 (单模式)
250*250mm



G系列
TBW08003C
TBW08003C#MBL*1

埋墙式花洒 (单模式)
300*300mm



G系列
TBW07001C
TBW07001C#MBL*1

埋墙式花洒 (单模式)
Ø200mm



G系列
TBW07002C
TBW07002C#MBL*1

埋墙式花洒 (单模式)
Ø250mm



G系列
TBW07003C
TBW07003C#MBL*1

埋墙式花洒 (单模式)
Ø300mm



G系列
TBW08001C1
TBW08001C1#MBL*1

顶置式花洒 (单模式)
200*200mm



G系列
TBW08002C1
TBW08002C1#MBL*1

顶置式花洒 (单模式)
250*250mm



G系列
TBW08003C1
TBW08003C1#MBL*1

顶置式花洒 (单模式)
300*300mm



镀铬

拉丝镍 #BN

抛光钛金 #PFG

抛光铜色 #PBR

哑光黑 #MBL

*1 本商品包含一部分PVD涂层

*2 本商品是喷涂涂层
(非2022reddot获奖对象)



reddot winner 2022

相同的颜色名称, 根据商品材料和材质的不同, 颜色也可能存在差异。



G系列
TBW07001C1
TBW07001C1#MBL*1

顶置式花洒 (单模式)
Ø200mm



G系列
TBW07002C1
TBW07002C1#MBL*1

顶置式花洒 (单模式)
Ø250mm



G系列
TBW07003C1
TBW07003C1#MBL*1

顶置式花洒 (单模式)
Ø300mm



G系列
TBW02004BA
TBW02004BB#MBL*2

埋墙式花洒 (二模式)
210*210mm



G系列
TBW02003BA
TBW02003BB#MBL*2

埋墙式花洒 (单模式)
210*210mm



G系列
TBW01004BA
TBW01004BB#MBL*2

埋墙式花洒 (二模式)
Ø220mm



G系列
TBW01003BA
TBW01003BB#MBL*2

埋墙式花洒 (单模式)
Ø220mm



G系列
TBW02003B1A
TBW02003B1B#MBL*2

顶置式花洒 (单模式)
200*200mm



G系列
TBW01003B1A
TBW01003B1B#MBL*2

顶置式花洒 (单模式)
Ø220mm



L系列
TBW10000C1

埋墙式花洒
(单模式)



L系列
TBW10010C1

顶置式花洒
(单模式)



L系列
TBW10020C1

埋墙式花洒
(单模式)



L系列
TBW10030C1

顶置式花洒
(单模式)



L系列
TBW01012B

埋墙式花洒



L系列
TBW01013B

埋墙式花洒 (五模式)



L系列
TBW03001B

埋墙式花洒 (五模式)

抛光玫瑰金 #PRG

拉丝石墨灰 #BGP

拉丝钛灰 #BTN

拉丝铜色 #BBR

| | | | |
|---|---|---|---|
|  | NEW  |  |  |
| G系列 TBW15CE0C TBW15CE0C#MBL*1 | G系列 TBW15DE0C TBW15DE0C#MBL*1 | G系列 TBW01036C3 | G系列 TBW02015C3 TBW02015C3#MBL*1 |
| 壁挂式手持花洒 (四模式) | 壁挂式手持花洒 (四模式) (一键止水) | 壁挂式喷雾花洒 (三模式) | 壁挂式手持花洒 (三模式) |
|  |  |  |  |
|  |  | | |
| TBW01025C | TBW01025C | TBW01025C | TBW02014C |
| 花洒支架 | 花洒支架 | 花洒支架 | 花洒支架 |
| TBW01027C | TBW01027C | TBW01027C | TBW01027C |
| 淋浴软管 *花洒软管、支架另需购买 | 淋浴软管 *花洒软管、支架另需购买 | 淋浴软管 *花洒软管、支架另需购买 | 淋浴软管 *花洒软管、支架另需购买 |

| | | | |
|---|---|---|---|
|  |  |  |  |
| L系列 TBW09010C2 | L系列 TBW09000C1 | L系列 TBW09000C2 | L系列 TBW07032C1 |
| 壁挂式手持花洒 (三模式) | 壁挂式手持花洒 (单模式) | 壁挂式手持花洒 (单模式) | 壁挂式手持花洒 (三模式) |
|  | |  |  |
| TBW01026C | TBW01026C | TBW01026C | TBW01025C |
| 淋浴软管 *花洒软管另需购买 | 淋浴软管 *花洒软管另需购买 | 淋浴软管 *花洒软管另需购买 | 花洒支架 TBW01026C |
| | | | 淋浴软管 *花洒软管、支架另需购买 |

| | | | |
|---|---|---|---|
|  |  |  |  |
| G系列 TBW02010C3 TBW02010C3#MBL*1 | G系列 TBW01021C3 TBW01021C3#MBL*1 | G系列 TBW01020C3 TBW01020C3#MBL*1 | G系列 TBW01021C3 |
| 壁挂式手持花洒 (单模式) | 壁挂式手持花洒 (三模式) | 壁挂式手持花洒 (单模式) | 埋墙式手持花洒 (三模式) |
|  |  |  |  |
| TBW02014C | TBW01025C | TBW01025C | DBX111 |
| 花洒支架 | 花洒支架 | 花洒支架 | 带进水件支架 |
| TBW01027C | TBW01027C | TBW01027C | TBW01027C |
| 淋浴软管 *花洒软管、支架另需购买 | 淋浴软管 *花洒软管、支架另需购买 | 淋浴软管 *花洒软管、支架另需购买 | 淋浴软管 *花洒软管、支架另需购买 |

| | | | |
|---|---|---|---|
|  |  |  |  |
| L系列 TBW07032C | L系列 TBW07033C1 | L系列 TBW07033C | G系列 TBW08008C |
| 壁挂式手持花洒 (三模式) | 壁挂式手持花洒 (二模式) | 壁挂式手持花洒 (二模式) | 埋墙式身体花洒 |
|  |  |  |  |
| TBW01025C | TBW01025C | TBW01025C | |
| 花洒支架 | 花洒支架 | 花洒支架 | |
| TBW01026C | TBW01026C | TBW01026C | |
| 淋浴软管 *花洒软管、支架另需购买 | 淋浴软管 *花洒软管、支架另需购买 | 淋浴软管 *花洒软管、支架另需购买 | |

| | | | |
|---|---|--|---|
|  |  |  |  |
| G系列 TBW01020C3 | G系列 TBW02016C3 TBW02016C3#MBL*1 | DM710CAFR | L系列 TBW09010C1 TBW09010C1#GP |
| 埋墙式手持花洒 (单模式) | 壁挂式手持花洒 (单模式) | 壁挂式手持花洒 (气泡式) | 壁挂式手持花洒 (三模式) |
|  |  |  | |
| DBX111 | TBW02014C | | TBW01026C |
| 带进水件支架 | 花洒支架 | | 淋浴软管 *花洒软管另需购买 |
| TBW01027C | TBW01027C | | |
| 淋浴软管 *花洒软管、支架另需购买 | 淋浴软管 *花洒软管、支架另需购买 | | |

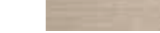
| | | | | | | | | |
|---|---|---|---|---|---|---|---|---|
|  |  |  |  |  |  |  |  |  |
| 镀铬 | 拉丝镍 #BN | 抛光法兰金 #PFG | 抛光铜色 #PBR | 哑光黑 #MBL *1 本商品包含一部分PVD涂层 *2 本商品是喷涂涂层 (非2022reddot获奖对象) | 抛光玫瑰金 #PRG | 拉丝石墨灰 #BGP | 拉丝钛灰 #BTN | 拉丝铜色 #BBR |



G系列
TBV124B0C
TBV124B0C#MBL*1

置物功能恒温水嘴
SMA恒温



G系列
TBV124A0C
TBV124A0C#MBL*1

置物功能恒温水嘴
SMA恒温



G系列
TBV01401BA
TBV01401BA#MBL

壁式双柄双控淋浴水嘴
SMA恒温



G系列
TBV01402BA
TBV01402BA#MBL

壁式双柄双控浴缸水嘴
SMA恒温



G系列
TBV03429BA

壁式双柄双控浴缸水嘴(拱形把手)
SMA恒温
*不对应其他颜色



G系列
TBV03427BA

壁式双柄双控浴缸水嘴
SMA恒温
*不对应其他颜色



G系列
TBV03431BA

壁式双柄双控淋浴水嘴
SMA恒温
*不对应其他颜色



L系列
TBV10400C

置物功能恒温水嘴
*不对应其他颜色



L系列
TBV10410C

置物功能恒温水嘴
*不对应其他颜色



L系列
TBV09400C

恒温水嘴
*不对应其他颜色



L系列
TBV09410C

恒温水嘴
*不对应其他颜色

镀铬

拉丝镀铬 #BN

抛光法兰金 #PFG

抛光铜色 #PBR

哑光黑 #MBL

*1 本商品包含一部分PVD涂层
*2 本商品是喷涂涂层
(非2022reddot获奖对象)



reddot winner 2022

相同的颜色名称，根据商品材料和材质的不同，颜色也可能存在差异。



G系列
TBW160V0C

滑动式淋浴支架
900mm(方形)



G系列
TBW07018C

滑动式淋浴支架
950mm(方形)



G系列
TBW07019C
TBW07019C#MBL*1

滑动式淋浴支架
740mm(方形)



L系列
TBW01015B

滑动式淋浴支架
900mm(圆形)



L系列
TBW01016B

滑动式淋浴支架
600mm(圆形)



DS709R(不含花洒)

滑动式淋浴支架



DS740R

滑动式淋浴支架



G系列
TBW160N0C
TBW160N0C#MBL*1

埋墙式淋浴头本体



抛光玫瑰金 #PRG



G系列
TBW07021C
TBW07021C#MBL*1

埋墙式淋浴头本体
(带花洒支架)



拉丝石墨灰 #BGP



G系列
TBW07020C
TBW07020C#MBL*2

埋墙式淋浴头本体



拉丝钛灰 #BTN



G系列
TBW08010C
TBW08010C#MBL*1
TBW08010C#PG

埋墙式淋浴头本体
(带花洒支架)



拉丝铜色 #BBR



G系列
TBW08009C
TBW08009C#MBL*2

埋墙式淋浴头本体

| | | | | |
|---|---|---|--|---|
|  |  |  |  |  |
| G系列 TBW14SD0C TBW14SD0C#MBL*1 | G系列 TBW14SC0C TBW14SC0C#MBL*1 | G系列 TBW14UD0C TBW14UD0C#MBL*1 | G系列 TBW14UC0C TBW14UC0C#MBL*1 | G系列 TBW14WC0C TBW14WC0C#MBL*1 |
| 壁式恒温带置物架淋浴柱 (单模式)(带吐水口) SMA恒温 | 壁式恒温带置物架淋浴柱 (单模式) SMA恒温 | 壁式恒温带置物架淋浴柱 (二模式)(带吐水口) SMA恒温 | 壁式恒温带置物架淋浴柱 (二模式) SMA恒温 | 壁式恒温带置物架淋浴柱 (三模式) SMA恒温 |
|    |    |     |     |      |

| | | | |
|---|---|---|---|
|  |  |  |  |
| G系列 TBW08405C TBW08405C#MBL*1 | G系列 TBW08406C | G系列 TBW07403C | G系列 TBW07404C |
| 壁式恒温淋浴柱 (单模式)(带吐水口) SMA恒温 | 壁式恒温淋浴柱 (单模式) SMA恒温 | 壁式恒温淋浴柱 (单模式)(带吐水口) SMA恒温 | 壁式恒温淋浴柱 (单模式) SMA恒温 |
|    |    |    |    |

| | | | |
|---|---|---|---|
|  |  |  |  |
| G系列 TBW01401C TBW01401C#MBL*1 | G系列 TBW01402C | G系列 TBW01404C | G系列 TBW01407C |
| 壁式恒温淋浴柱 (单模式)(带吐水口) SMA恒温 | 壁式恒温淋浴柱 (单模式) SMA恒温 | 壁式恒温淋浴柱 (二模式) SMA恒温 | 壁式恒温淋浴柱 (二模式)(带吐水口) SMA恒温 |
|    |    |     |      |

| | | | |
|---|---|---|---|
|  |  |  |  |
| G系列 TBW01301C TBW01301C#MBL*1 | G系列 TBW01302C | G系列 TBW01001BA TBW01001BB#MBL*1 | G系列 TBW02001BA |
| 双柄双控淋浴柱 (单模式)(带吐水口) | 双柄双控淋浴柱 (单模式) | 壁式单柄转换阀 (单模式) | 壁式单柄转换阀 (单模式) |
|  |  |  |  |

| | | | | | |
|---|---|---|---|---|---|
|  |  |  |  |  |  |
| 镀铬 | 拉丝镀铬 #BN | 抛光法兰金 #PFG | 抛光铜色 #PBR | 哑光黑 #MBL | reddot winner 2022 |

*1 本商品包含一部分PVD涂层
*2 本商品是喷涂涂层
(非2022reddot获奖对象)

| | |
|---|---|
|  |  |
| MY5系列 TBW10420C#GP | MY5系列 TBW12480C#GP |
| 单柄按钮式恒温淋浴 明装普通水压花洒套装 | 单柄按钮式恒温淋浴 明装普通水压花洒套装 |
|  |  |

| | |
|---|---|
|  |  |
| L系列 TBW12400C TBW12400C#GP | L系列 TBW12410C |
| 壁式恒温带置物架淋浴柱 (单模式)(带吐水口) | 壁式恒温带置物架淋浴柱 (单模式) |
|  |  |

| | | | |
|---|---|---|---|
|  |  |  |  |
| L系列 TBW11440C | L系列 TBW11450C | L系列 TBW11460C | L系列 TBW11470C |
| 壁式恒温淋浴柱 (单模式)(带吐水口)(高度可调) | 壁式恒温淋浴柱 (单模式)(高度可调) | 壁式恒温淋浴柱 (单模式)(带吐水口) | 壁式恒温淋浴柱(单模式) |
|  |  |  |  |

| | | | |
|---|---|---|---|
|  |  |  |  |
| L系列 TBW13020C2 | L系列 TBW13030C2 | L系列 TBW13040C2 | L系列 TBW13050C2 |
| 壁式伸缩淋浴柱 壁式单柄转换阀(单模式) | 壁式无伸缩淋浴柱 壁式单柄转换阀(单模式) | 壁式伸缩淋浴柱 壁式单柄转换阀(单模式) | 壁式无伸缩淋浴柱 壁式单柄转换阀(单模式) |
|  |  |  |  |

| | | | |
|---|---|---|---|
|  |  |  |  |
|---|---|---|---|

相同的颜色名称, 根据商品材料和材质的不同, 颜色也可能存在差异。



TBW07411C

壁式恒温淋浴柱 (单模式)



DM918CAR

双柄双控淋浴柱 (单模式) (带吐水口)



DM919CAR

双柄双控淋浴柱 (单模式)



镀铬

多种浴室都可方便地安装

凭借先进科技，产品加载了 TOTO 引以为傲的集成化小型迷你单元组件。在不给浴室布局添加负担的情况下，轻松提升浴室品味和档次。



百灵盒

MINI UNIT

Ø112mm



面板自由组合技术

小巧精致， 让浴室更美观

埋墙式水嘴使浴室焕然一新。TOTO的MINI UNIT面板自由组合技术，大幅提升安装的自由度。水嘴共通化设计，埋墙的阀芯部分无需和外观部件一一匹配。单柄式面板、恒温式面板、按键式面板，你可根据自己喜好自由选择，你更可按个人喜好选择不同的产品外观（圆形/方形）

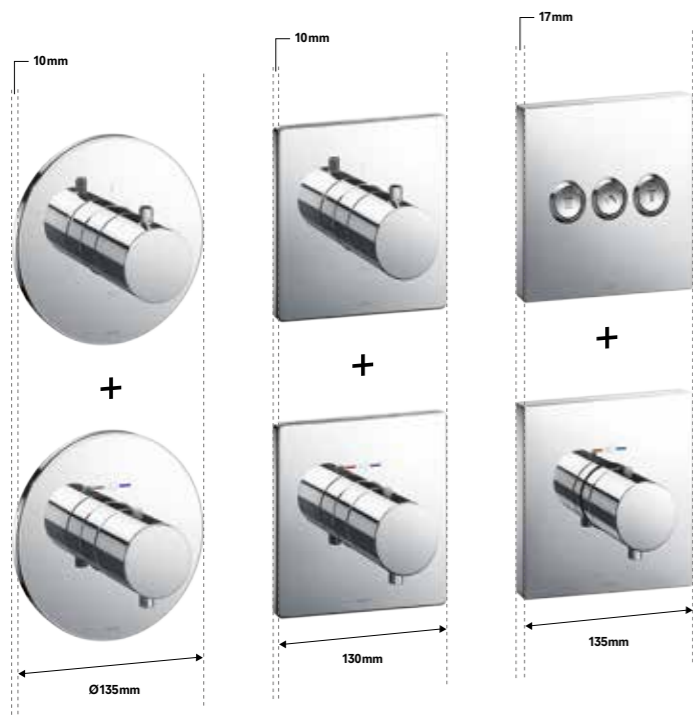

灵活小巧，时尚之美

我们竭力将产品最小化设计的同时，也努力缩小边缘厚度，使产品尽可能的“薄”。除了灵活小巧的外形，我们在统一尺寸方面也有所改进，可以同时使用多种装置，创建美好的空间，从而让您拥有一间风格统一并时尚的浴室。

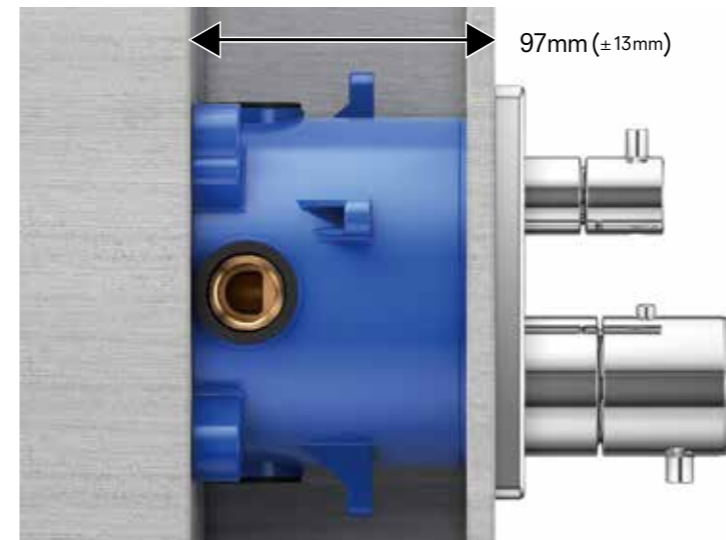
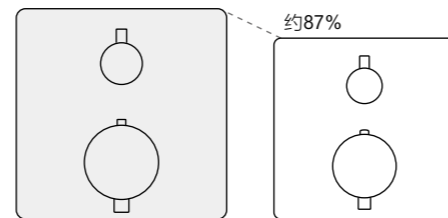



































易于安装，墙壁负荷小。

面板自由组合技术的安装具有高度的灵活性，我们的面板自由组合技术能够达到非常小和轻的水平。它仅对建筑框架施加很小的负荷，并且提高了安装过程中的可管理性。墙壁厚度仅需97mm便可安装，并且面板自由组合技术能够容纳±13mm的安装误差。

1路、2路、3路、4路出水专用

| | | | |
|---|--|---|--|
| <p>2路出水</p>  <p>G系列 TBV11120C TBV11120C#MBL /TBN11BC0C</p> <p>横联埋入式恒温面板 / 阀体 (开闭切换)</p>  <p>1路、2路、3路、4路出水专用</p> | <p>3路出水</p>  <p>G系列 TBV11130C TBV11130C#MBL /TBN11DC0C</p> <p>横联埋入式恒温面板 / 阀体 (开闭切换)</p>  | <p>4路出水</p>  <p>G系列 TBV11140C TBV11140C#MBL /TBN11FC0C</p> <p>横联埋入式恒温面板 / 阀体 (开闭切换)</p>   | <p>5路出水</p>  <p>G系列 TBV11150C TBV11150C#MBL /TBN11HC0C</p> <p>横联埋入式恒温面板 / 阀体 (开闭切换)</p>   |
|---|--|---|--|









| | | | |
|---|--|---|---|
| <p>1路出水</p>  <p>TBV01407B TBV01407BA#MBL /TBN01001C</p> <p>壁式双柄恒温暗装水嘴面板 / 阀体 (开闭切换)</p>   | <p>2路出水</p>  <p>TBV01408B TBV01408BA#MBL /TBN01001C</p> <p>壁式双柄恒温暗装水嘴面板 / 阀体 (二种出水切换, 开闭切换)</p>   | <p>3路出水</p>  <p>TBV01406B TBV01406BA#MBL /TBN01001C</p> <p>壁式单柄恒温暗装水嘴面板 / 阀体</p>   | <p>3路出水</p>  <p>TBV01102B /TBN01101B TBV01102BA#MBL /TBN01101B#MBL</p> <p>壁式单柄暗装三向转换面板 / 阀体 (三种出水切换, 开闭切换)</p>   |
| <p>2路出水</p>  <p>TBV02403B TBV02403BA#MBL /TBN01001C</p> <p>壁式双柄恒温暗装水嘴面板 / 阀体 (开闭切换)</p>   | <p>2路出水</p>  <p>TBV02404B TBV02404BA#MBL /TBN01001C</p> <p>壁式双柄恒温暗装水嘴面板 / 阀体 (二种出水切换, 开闭切换)</p>   | <p>3路出水</p>  <p>TBV02401B TBV02401BA#MBL /TBN01001C</p> <p>壁式单柄恒温暗装水嘴面板 / 阀体</p>   | <p>3路出水</p>  <p>TBV02102B /TBN01101B TBV02102BA#MBL /TBN01101B#MBL</p> <p>壁式单柄暗装三向转换面板 / 阀体 (三种出水切换, 开闭切换)</p>   |
| <p>2路出水</p>  <p>TBV02405B TBV02405BA#MBL*2 /TBN01001C</p> <p>壁式单柄恒温暗装水嘴面板 / 阀体 (开闭切换, 按启式)</p>   | <p>2路出水</p>  <p>TBV02406B TBV02406BAB#MBL*2 /TBN01001C</p> <p>壁式单柄恒温暗装水嘴面板 / 阀体 (开闭切换, 按启式)</p>   | <p>3路出水</p>  <p>TBV02402B TBV02402BA#MBL /TBN01001C</p> <p>壁式单柄恒温暗装水嘴面板 / 阀体</p>   | <p>3路出水</p>  <p>TBV02105B TBV02105BA#MBL *2 /TBN01001C</p> <p>壁式暗装三向转换面板 / 阀体 (开闭切换, 按启式)</p>  |

| | | | | | |
|--|---|--|---|--|---|
|  镀铬 |  拉丝镍 #BN |  抛光法兰金 #PFG |  抛光铜色 #PBR |  哑光黑 #MBL |  red dot winner 2022 |
|--|---|--|---|--|---|

*1 本商品包含一部分PVD涂层
*2 本商品是喷涂涂层
(非2022reddot获奖对象)

相同的颜色名称, 根据商品材料和材质的不同, 颜色也可能存在差异。

| | |
|--|--|
|  <p>TBN01001C 埋入盒装本体部</p>  |  <p>TBN01104B TBN01104B#MBL 壁式单柄暗装单向转换阀体 (开闭切换)</p> |
|--|--|

| | | |
|--|---|---|
|  <p>TBV01101B /TBN01104B TBV01101BA#MBL /TBN01104B#MBL</p> <p>壁式单柄暗装单向转换面板 / 阀体 (开闭切换)</p>  <p>TBV02101B /TBN01104B TBV02101BA#MBL /TBN01104B#MBL</p> <p>壁式单柄暗装单向转换面板 / 阀体 (开闭切换)</p>  <p>TBN01101B TBN01101B#MBL</p> <p>壁式单柄暗装三向转换阀体 (三种出水切换 / 开闭切换)</p> |  <p>TBV01103B /TBN01102B TBV01103BA#MBL /TBN01102B#MBL</p> <p>壁式单柄暗装双向转换面板 / 阀体 (二种出水切换)</p>  <p>TBV02103B /TBN01102B TBV02103BA#MBL /TBN01102B#MBL</p> <p>壁式单柄暗装双向转换面板 / 阀体 (二种出水切换)</p>  <p>TBN01102B TBN01102B#MBL</p> <p>壁式单柄暗装双向转换阀体 (二种出水切换)</p> |  <p>TBV01104B /TBN01103B TBV01104BA#MBL /TBN01103B#MBL</p> <p>壁式单柄暗装三向转换面板 / 阀体 (三种出水切换)</p>  <p>TBV02104B /TBN01103B TBV02104BA#MBL /TBN01103B#MBL</p> <p>壁式单柄暗装三向转换面板 / 阀体 (三种出水切换)</p>  <p>TBN01103B TBN01103B#MBL</p> <p>壁式单柄暗装三向转换阀体 (三种出水切换)</p> |
|--|---|---|

| | | | |
|--|--|---|---|
|  抛光玫瑰金 #PRG |  拉丝石墨灰 #BGP |  拉丝钛灰 #BTN |  拉丝铜色 #BBR |
|--|--|---|---|

4 种出水方式，自由选择。

1 路出水

恒温暗装水嘴面板

带流量控制

- ① 流量控制 (开/关)
- ② 温度控制

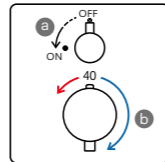

或

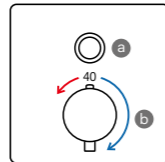

- ① 开/闭切换 (流量恒定)
- ② 温度控制

圆形



TBV01407B
壁式双柄恒温
暗装水嘴面板
(开闭切换)

方形



TBV02403B
壁式双柄恒温
暗装水嘴面板
(开闭切换)

方形 (按启式)



TBV02405B
壁式双柄恒温
暗装水嘴面板
(开闭切换)

所有系列通用部件



TBN01001C
埋入盒装本体部
(百灵盒)

组合产品清单

壁挂式手持花洒
TBW07033C

淋浴软管
TBW01026C

滑动式淋浴支架
TBW01016B

壁式双柄恒温暗装水嘴面板 (开闭切换)
TBV02403B

埋墙式淋浴头本体
TBW07020C

埋入盒装本体部 (百灵盒)
TBN01001C



2 路出水

恒温暗装水嘴面板

带二种出水切换控制

- ① 流量控制 (开/关)
- ② 转换
- ③ 温度控制

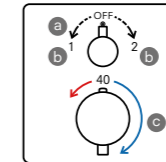

或

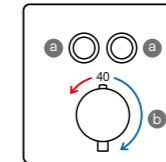

- ① 开/闭切换 (流量恒定)
- ② 温度控制

圆形



TBV01408B
壁式双柄恒温
暗装水嘴面板
(二种出水切
换, 开闭切换)

方形



TBV02404B
壁式双柄恒温
暗装水嘴面板
(二种出水切
换, 开闭切换)

方形 (按启式)



TBV02406B
壁式单柄恒温
暗装水嘴面板
(二种出水切
换, 开闭切换,
按启式)

所有系列通用部件



TBN01001C
埋入盒装本体部
(百灵盒)

组合产品清单

埋墙式花洒
TBW07003C

壁挂式手持花洒
TBW07032C

淋浴软管
TBW01026C

滑动式淋浴支架
TBW01016B

壁式双柄恒温暗装水嘴面板 (二种出水切换, 开闭切换)
TBV02404B

埋墙式淋浴头本体
TBW07020C

埋入盒装本体部 (百灵盒)
TBN01001C



3 路出水



恒温暗装水嘴面板

带三种出水切换和流量控制

- a 流量控制
- b 转换
- c 关闭

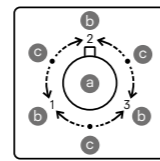

仅温度控制

- a 温度控制

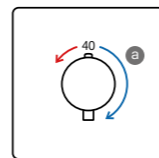

- a 开/闭切换 (流量恒定)

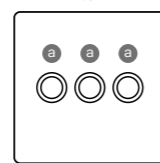

圆形



TBV01102B TBN01101B
壁式单柄暗装 (开闭切换) 三向转换面板 / 阀芯 (三种出水切换, 开闭切换)

方形



TBV02102B TBN01101B
壁式单柄暗装 (开闭切换) 三向转换面板 / 阀芯 (三种出水切换, 开闭切换)

方形 (按启式)



TBV02105B TBN01001C
壁式暗装 三向转换面板 / 阀芯 (三种出水切换, 开闭切换, 按启式) 埋入盒装本体部 (百灵盒)



TBV01406B TBN01001C
壁式单柄恒温 暗装水嘴面板 (百灵盒) 埋入盒装本体部



TBV02401B TBN01001C
壁式单柄恒温 暗装水嘴面板 (百灵盒) 埋入盒装本体部



TBV02402B TBN01001C
壁式单柄恒温 暗装水嘴面板 (百灵盒) 埋入盒装本体部

组合产品清单

埋墙式花洒
TBW08003C

壁挂式手持花洒
TBW01021C3

淋浴软管
TBW01027C

埋墙式身体花洒
TBW08008C×4

埋墙式淋浴头本体 (带花洒支架)
TBW08010C

壁式暗装三向转换面板 (三种出水切换, 开闭切换, 按启式)
TBV02105B

壁式单柄恒温暗装水嘴面板
TBV02402B

埋入盒装本体部 (百灵盒)
TBN01001C ×2

4 路出水



恒温暗装水嘴面板

带三种出水切换和流量控制

- a 流量控制
- b 转换
- c 关闭

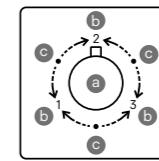

仅温度控制

- a 温度控制

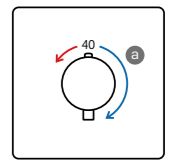

- a 开/闭切换 (流量恒定)

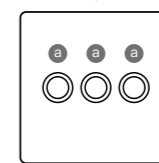

- a 开/闭切换

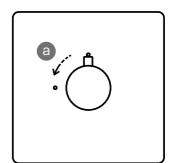

圆形



TBV01102B TBN01101B
壁式单柄暗装 (开闭切换) 三向转换面板 / 阀芯 (三种出水切换, 开闭切换)

方形



TBV02102B TBN01101B
壁式单柄暗装 (开闭切换) 三向转换面板 / 阀芯 (三种出水切换, 开闭切换)

方形 (按启式)



TBV02105B TBN01001C
壁式暗装 三向转换面板 / 阀芯 (三种出水切换, 开闭切换, 按启式) 埋入盒装本体部 (百灵盒)



TBV01406B TBN01001C
壁式单柄恒温 暗装水嘴面板 (百灵盒) 埋入盒装本体部



TBV02401B TBN01001C
壁式单柄恒温 暗装水嘴面板 (百灵盒) 埋入盒装本体部



TBV02402B TBN01001C
壁式单柄恒温 暗装水嘴面板 (百灵盒) 埋入盒装本体部



TBV01101B TBN01104B
壁式单柄暗装单向转换面板 / 阀体 (开闭切换)



TBV02101B TBN01104B
壁式单柄暗装单向转换面板 / 阀体 (开闭切换)



TBV02101B TBN01104B
壁式单柄暗装单向转换面板 / 阀体 (开闭切换)

组合产品清单

埋墙式花洒
TBW08003C

壁挂式手持花洒
TBW02016C3

淋浴软管
TBW01027C

吐水口
TBP02001B1

埋墙式身体花洒
TBW08008C ×4

埋墙式淋浴头本体 (带花洒支架)
TBW08010C

壁式暗装三向转换面板 (三种出水切换, 开闭切换, 按启式)
TBV02105B

壁式单柄恒温暗装水嘴面板 (开闭切换)
TBV02402B

壁式单柄暗装单向转换面板 (开闭切换)
TBV02101B

壁式单柄暗装单向转换阀体 (开闭切换)
TBN01104B

埋入盒装本体部 (百灵盒)
TBN01001C ×2



DL352R

台式单柄双控洗面器水嘴
附排水金具



DL352-1R

台式单柄双控洗面器水嘴
(搭配桌上式洗面器)
吐水高度 217mm
附排水金具



① DM344R

壁式单柄双控淋浴水嘴



② TBW01020C3

壁挂式手持花洒 (单模式)

TBW01025C

树脂花洒支架

TBW01027C

淋浴软管



① DM343R

壁式单柄双控浴缸水嘴



② TBW01020C3

壁挂式手持花洒 (单模式)

TBW01025C

树脂花洒支架

TBW01027C

淋浴软管



① TBW01013B

埋墙式花洒



② DP323RR
/TBN103D0C

壁式单柄双控暗装水嘴面板
壁式单柄双控暗装水嘴阀体
(二种出水切换, 开闭切换)



③ TBG01001B

吐水口



④ TBW01020C3

埋墙式手持花洒 (单模式)

推荐搭配:

①+②+③

①+②+④

DBX111

树脂花洒支架

TBW01027C

淋浴软管



DL376R

台式单柄双控洗面器水嘴
附排水金具



①



① TBW08002C

埋墙式淋浴花洒



②



② DB358S
/TBN103C0C

壁式单柄双控暗装水嘴面板 / 阀体
(开闭切换)

DL376-1S

台式单柄双控洗面器水嘴
(搭配桌上式洗面器)
附排水金具



①



① TBW08002C1

埋墙式淋浴花洒



② DB359S
/TBN103D0C

壁式单柄双控暗装水嘴面板 / 阀体
(二种出水切换, 开闭切换)



① DM367R

壁式单柄双控淋浴水嘴



② TBW07032C

壁挂式手持花洒 (三模式)

TBW01025C

树脂花洒支架

TBW01026C

淋浴软管

②



③ TBW07032C

壁挂式手持花洒 (三模式)
推荐搭配:
①+②+③



TBW01025C

树脂花洒支架

TBW01026C

淋浴软管



① DM368R

壁式单柄双控浴缸水嘴 (可转换)



② TBW07032C

壁挂式手持花洒 (三模式)

TBW01025C

树脂花洒支架

TBW01026C

淋浴软管

| | | |
|---|----------------|------------------------|
|  | DL378 NEW | 台式单柄双控洗面器水嘴 (附排水金具) |
|  | DL378-1 NEW | 台式单柄双控洗面器水嘴 (附排水金具) |
|  | DL378-2 NEW | 台式单柄双控洗面器水嘴 (附排水金具) |
|  | DL379 NEW | 台式单柄双控洗面器水嘴 |
|  | DL379-1 NEW | 台式单柄双控洗面器水嘴 |
|  | DL379-2 NEW | 台式单柄双控洗面器水嘴 |

| | | | |
|--|---|---|---|
|   | ① TBW07032C ② DM353AS TBW01025C TBW01026C | 壁挂式手持花洒 (三模式) 壁式单柄双控淋浴水嘴 树脂花洒支架 淋浴软管 |  |
|   | ① TBW07032C ② DM355S TBW01025C TBW01026C | 壁挂式手持花洒 (三模式) 壁式单柄双控浴缸水嘴 树脂花洒支架 淋浴软管 |  |
|   | ① TBW01013B ② DB341S /TBN103C0C | 埋墙式花洒 (五模式) 壁式单柄双控暗装水嘴面板 / 阀体 (开闭切换) | |
|     | ① TBW01013B ② DB341AS /TBN103D0C ③ TBW07032C TBW01025C TBW01026C | 埋墙式花洒 (五模式) 壁式单柄双控暗装水嘴面板 / 阀体 (二种出水切换, 开闭切换) 壁挂式手持花洒 (三模式) 推荐搭配: ①+②+③ 树脂花洒支架 淋浴软管 |  |



DL367#PG (金色) 台式单柄双控洗面器水嘴 附排水金具



DL367-1#PG (金色) 台式单柄双控洗面器水嘴 (搭配半埋入台式洗面器) 附排水金具



DL367-2#PG (金色) 台式单柄双控洗面器水嘴 (搭配桌上式洗面器) 附排水金具



DLB202#PG (金色) 壁式双柄双控暗装洗面器水嘴 附排水金具



DL224#PG (金色) 台式双柄双控洗面器水嘴 附排水金具



DB244C#PG (金色) 台式双柄双控浴缸水嘴 (带手持花洒)



DM209CF#PG (金色) 立式双柄双控浴缸水嘴 (带手持花洒)

| | | | | |
|---|---|---|--|---|
| ① |  | ① DBX121CAMR#PG (金色) DBX121-1CAM#PG (金色) | 埋墙式花洒 (空气按摩式) Ø323mm |  |
| ② |  | ② DP354#PG (金色) DV105R | 壁式单柄暗装单向转换面板 壁式单柄暗装单向转换阀体 (开闭切换) | |
| ③ |  | ③ DP422#PG (金色) DV418 | 壁式单柄恒温暗装水嘴面板 壁式单柄恒温暗装水嘴阀体 SMA 恒温 | |













| | | | | |
|---|---|---|--|---|
| ① |  | ① DBX121CAMR#PG (金色) DBX121-1CAM#PG (金色) | 埋墙式花洒 (空气按摩式) Ø323mm |  |
| ② |  | ② DP355#PG (金色) DV104 | 壁式单柄暗装双向转换面板 壁式单柄暗装双向转换阀体 (二种出水切换, 开闭切换) | |
| ③ |  | ③ DP422#PG (金色) DV418 | 壁式单柄恒温暗装水嘴面板 壁式单柄恒温暗装水嘴阀体 SMA 恒温 | |
| ④ |  | ④ DBS113#PG (金色) | 吐水口 | |





| | | | | |
|---|---|---|--|---|
| ① |  | ① TBW01020C3#PG (金色) TBW01020C3 (镀铬) | 埋墙式手持花洒 (单模式) |  |
| | | TBW08010C#PG (金色) | 带进水件支架 | *花洒软管、支架另需购买 |
| | | TBW01027C#PG (金色) | 淋浴软管 | |
| ② |  | ② DP354#PG (金色) DV105R | 壁式单柄暗装单向转换面板 壁式单柄暗装单向转换阀体 (开闭切换) | |
| ③ |  | ③ DP422#PG (金色) DV418 | 壁式单柄恒温暗装水嘴面板 壁式单柄恒温暗装水嘴阀体 SMA 恒温 | |

| | | | | |
|---|---|---|--|---|
| ① |  | ① TBW01020C3#PG (金色) TBW01020C3 (镀铬) | 埋墙式手持花洒 (单模式) |  |
| | | TBW08010C#PG (金色) | 带进水件支架 | *花洒软管、支架另需购买 |
| | | TBW01027C#PG (金色) | 淋浴软管 | |
| ② |  | ② DP355#PG (金色) DV104 | 壁式单柄暗装双向转换面板 壁式单柄暗装双向转换阀体 (二种出水切换, 开闭切换) | |
| ③ |  | ③ DP422#PG (金色) DV418 | 壁式单柄恒温暗装水嘴面板 壁式单柄恒温暗装水嘴阀体 SMA 恒温 | |
| ④ |  | ④ DBS113#PG (金色) | 吐水口 | |

| | | | | |
|---|---|---|--|---|
| ① |  | ① DBX121CAMR#PG (金色) DBX121-1CAM#PG (金色) | 埋墙式花洒 (空气按摩式) Ø323mm |  |
| ② |  | ② DP355#PG (金色) DV104 | 壁式单柄暗装双向转换面板 壁式单柄暗装双向转换阀体 (二种出水切换, 开闭切换) | |
| ③ |  | ③ DP422#PG (金色) DV418 | 壁式单柄恒温暗装水嘴面板 壁式单柄恒温暗装水嘴阀体 SMA 恒温 | |
| ④ |  | ④ TBW01020C3#PG (金色) TBW01020C3 (镀铬) | 埋墙式手持花洒 (单模式) |  |
| | | TBW08010C#PG (金色) | 带进水件支架 | *花洒软管、支架另需购买 |
| | | TBW01027C#PG (金色) | 淋浴软管 | |





| | | | | |
|---|---|---|--|---|
| ① |  | ① DBX121CAMR#PG (金色) DBX121-1CAM#PG (金色) | 埋墙式花洒 (空气按摩式) Ø323mm |  |
| ③ |  | ② TBW01020C3#PG (金色) TBW01020C3 (镀铬) | 埋墙式手持花洒 (单模式) |  |
| | | TBW08010C#PG (金色) | 带进水件支架 | *花洒软管、支架另需购买 |
| | | TBW01027C#PG (金色) | 淋浴软管 | |
| ④ |  | ③ DP355#PG (金色) DV104 | 壁式单柄暗装双向转换面板 壁式单柄暗装双向转换阀体 (二种出水切换, 开闭切换) | |
| ⑤ |  | ④ DP422#PG (金色) DV418 | 壁式单柄恒温暗装水嘴面板 壁式单柄恒温暗装水嘴阀体 SMA 恒温 | |
| ⑥ |  | ⑤ P345#PG (金色) DV105R | 壁式单柄暗装单向转换面板 壁式单柄暗装单向转换阀体 (开闭切换) | |
| | | ⑥ DBS113#PG (金色) | 吐水口 | |

| | | | |
|---|---------------------------------------|-------------------------|---|
|  | DBX121CAMR#PG (金色) | 埋墙式花洒 (空气按摩式) Ø323mm |  |
|  | DBX120CAMR#PG (金色) | 埋墙式花洒 (空气按摩式) Ø223mm |  |
|  | DBX121-1CAM#PG (金色) | 顶置式花洒 (空气按摩式) Ø323mm |  |
|  | DBX120-1CAM#PG (金色) | 顶置式花洒 (空气按摩式) Ø223mm |  |
|  | TBW01020C3#PG (金色) TBW01020C3 (镀铬) | 埋墙式手持花洒 (单模式) Ø110mm |  |
| | TBW08010C#PG (金色) | 带进水件支架 | *花洒软管、支架另需购买 |
| | TBW01027C#PG (金色) | 淋浴软管 | |
|  | TBW01021C3#PG (金色) TBW01021C3 (镀铬) | 埋墙式手持花洒 (三模式) Ø110mm |  |
| | TBW08010C#PG (金色) | 带进水件支架 | *花洒软管、支架另需购买 |
| | TBW01027C#PG (金色) | 淋浴软管 | |





| | | |
|---|-------------------------|--|
|  | DP354#PG (金色) DV105R | 壁式单柄暗装单向转换面板 壁式单柄暗装单向转换阀体 (开闭切换) |
|  | DP422#PG (金色) DV418 | 壁式单柄恒温暗装水嘴面板 壁式单柄恒温暗装水嘴阀体 SMA 恒温 |
|  | DP355#PG (金色) DV104 | 壁式单柄暗装双向转换面板 壁式单柄暗装双向转换阀体 (二种出水切换, 开闭切换) |
|  | DBS113#PG (金色) | 吐水口 |

COLOR VARIATION | 多彩选择

● : 标准商品
○ : 定制生产商品 (预计交货期请咨询门店销售顾问)

| | | Cr | BN | PFG | PBR | BBR |
|--------------|-------|---|---|---|---|---|
| | |  |  |  |  |  |
| Z 系列花洒 | 埋入式花洒 | ● | ○ TBW07004C *1 | ○ | ○ | ○ |
| G 系列花洒 | 手持花洒 | ● | ○ | ○ | ○ | ○ |
| | 埋入式花洒 | ● | ○ | ○ | ○ | ○ |
| | 顶置式花洒 | ● | ○ | ○ | ○ | ○ |
| Z 系列淋浴柱 | 恒温 | ● | ○ | - | - | - |
| G 系列淋浴柱 | 恒温 | ● | ○ | ○ | ○ | ○ |
| | 双柄双控 | ● | ○ | ○ | ○ | ○ |
| | 单柄转换阀 | ● | ○ | ○ | ○ | ○ |
| G 系列滑动式淋浴支架 | 900mm | ● | ○ | ○ | ○ | ○ |
| | 950mm | ● | - | - | - | - |
| | 740mm | ● | ○ | ○ | ○ | ○ |
| G 系列埋墙式淋浴头本体 | | ● | ○ | ○ | ○ | ○ |
| G 系列恒温淋浴 | 面板 | ● | ○ TBV02402B *1 | ○ | ○ | ○ |
| | 水嘴 | ● | ○ | ○ | ○ | ○ |

*1 该型号为标准商品
*2 该型号为定制生产商品 (预计交货期请咨询门店销售顾问)

| PRG | MBL | BGP | BTN |
|---|--|---|---|
|  |  <small>red dot winner 2022 哑光黑 (#MBL)</small> |  |  |
| ○ | ○ | ○ | ○ |
| ○ | ● TBW02016C3*2 | ○ | ○ TBW15CE0C*1 |
| ○ | ○ TBW08002C *1 TBW07002C *1 TBW15AB0C*1 | ○ | ○ TBW15AB0C*1 |
| ○ | ○ TBW08002C1 *1 TBW07002C1 *1 | ○ | ○ |
| - | - | - | - |
| ○ | - TBW08405C *1 TBW01401C *1 TBW14SD0C*1 TBW14SC0C*2 TBW14UD0C*2 TBW14UC0C*2 TBW14WC0C*2 | ○ | ○ TBW14SD0C*1 |
| ○ | - TBW01301C *2 | ○ | ○ |
| ○ | - TBW01001BB *2 | ○ | ○ |
| ○ | ● | ○ | ● |
| - | - | - | - |
| ○ | ● | ○ | ○ |
| ○ | ○ TBW07020C *1 TBW08009C *1 TBW160N0C*1 | ○ | ○ TBW160N0C*1 |
| ○ | ○ TBV01408BA *1 TBV02404BA *1 TBV02406BA *1 TBV11120C*1 | ○ | ○ TBV11120C*1 |
| ○ | - TBV01401BA *2 TBV01402BA *2 TBV124B0C*1 TBV124A0C*2 | ○ | ○ TBV124B0C*1 TBV124A0C*2 |



抽取式洗面器水嘴
舒适愉悦的家庭时光

值得信赖的品质满足您的日常需求



为日常舒适使用而设计的水嘴



抽取式水嘴，方便日常洗手



易清洁的洗面器



柔和的气泡水流，减少飞溅，适合接水











宠物漫步归来，轻松舒适的足部清洁



升降便捷
*仅限TLS083J0C

抽取式洗面器水嘴产品













| | | | |
|--|---|--|---|
|  <p>镀铬 拉丝镀铬</p> | <p>TBP01301C (镀铬) TBP01301C#BN (拉丝镀铬)</p> | <p>立式单柄双控浴缸水嘴 (带手持花洒) 需另配阀体 TBN01105B 推荐搭配: 晶雅石材质气泡冲浪按摩浴缸 PJYD2200PW</p> |  |
|  | <p>DM334CFRR NEW</p> | <p>立式单柄双控浴缸水嘴 (带手持花洒)</p> |  |
|  | <p>TBG05301BA</p> | <p>台式单柄双控浴缸水嘴 (可转换、带手持花洒) 搭配 DB903R 系列使用</p> | |
|  | <p>DB252 DBS111</p> | <p>壁式双柄双控暗装水嘴 吐水口</p> | |
|  | <p>TBW02016C3 DB253R DBS111 TBW02014C TBW01027C</p> | <p>壁挂式手持花洒 壁式双柄双控暗装水嘴 吐水口 树脂花洒支架 淋浴软管</p> |  *花洒软管、支架另需购买 |

| | | | |
|---|-----------------------------------|---|--|
|  | <p>TLS073J0C TLS073J0C#GP</p> | <p>台式单柄双控洗面器抽取式水嘴 无排水金具 水嘴可拉出(软管连接)</p> |  |
|  | <p>TLS083J0C TLS083J0C#GP</p> | <p>台式单柄双控洗面器抽取式水嘴 无排水金具 吐水口可切换花洒状出水 水嘴可拉出(软管连接)</p> |  |
|  | <p>TLS093B0C TLS093B0C#GP</p> | <p>台式单柄双控洗面器抽取式水嘴 无排水金具 吐水口可切换花洒状出水 水嘴可拉出(软管连接)</p> |  |
|  | <p>TLG12303B</p> | <p>台式单柄双控洗面器抽取式水嘴 无排水金具 水嘴可拉出(软管连接)</p> |   |
|  | <p>DL388CS</p> | <p>台式单柄双控洗面器抽取式水嘴 附排水金具 吐水口可切换花洒状出水 水嘴可拉出(软管连接)</p> |  |
|  | <p>DL388C1S</p> | <p>台式单柄双控洗面器抽取式水嘴 无排水金具 吐水口可切换花洒状出水 水嘴可拉出(软管连接)</p> |  |
|  | <p>DL361CN</p> | <p>台式单柄双控洗面器抽取式水嘴 附排水金具 吐水口可切换花洒状出水 水嘴可拉出(软管连接)</p> |  |

枪灰色 # GP

| | | | |
|---|---------|--------------------------------------|---|
|  | DL369 | 台式单柄双控洗面器水嘴 附排水金具 |  |
|  | DL369-1 | 台式单柄双控洗面器水嘴 (搭配半埋入台式洗面器) 附排水金具 |  |
|  | DL104R | 台式单柄单控洗面器水嘴 |  |

| | | | |
|---|---------------------------------|---------------------------------------|---|
|  | DK304CR | 台式单柄双控厨房抽取式水嘴 两种吐水方式 |  |
|  | DK302CRR | 台式单柄双控厨房抽取式水嘴 两种吐水方式 吐水管 70 度旋转 |  |
|  | DK306S | 台式单柄双控厨房水嘴 吐水管 360 度旋转 |  |
|  | TKS06301C <small>NEW</small> | 台式单柄双控厨房抽取式水嘴 吐水管 360 度旋转 |  |
|  | TKS07301C <small>NEW</small> | 台式单柄双控厨房水嘴 |  |



D103N

单柄单控洗衣机水嘴



D103-1N

单柄单控洗衣机水嘴（自动止水型）



DBS105C

单柄单控洗涤水嘴
90度开闭



DBS105S

单柄单控洗涤水嘴
90度开闭



DL102

延时自闭水嘴
无提拉头及排水金具



BATHTUB

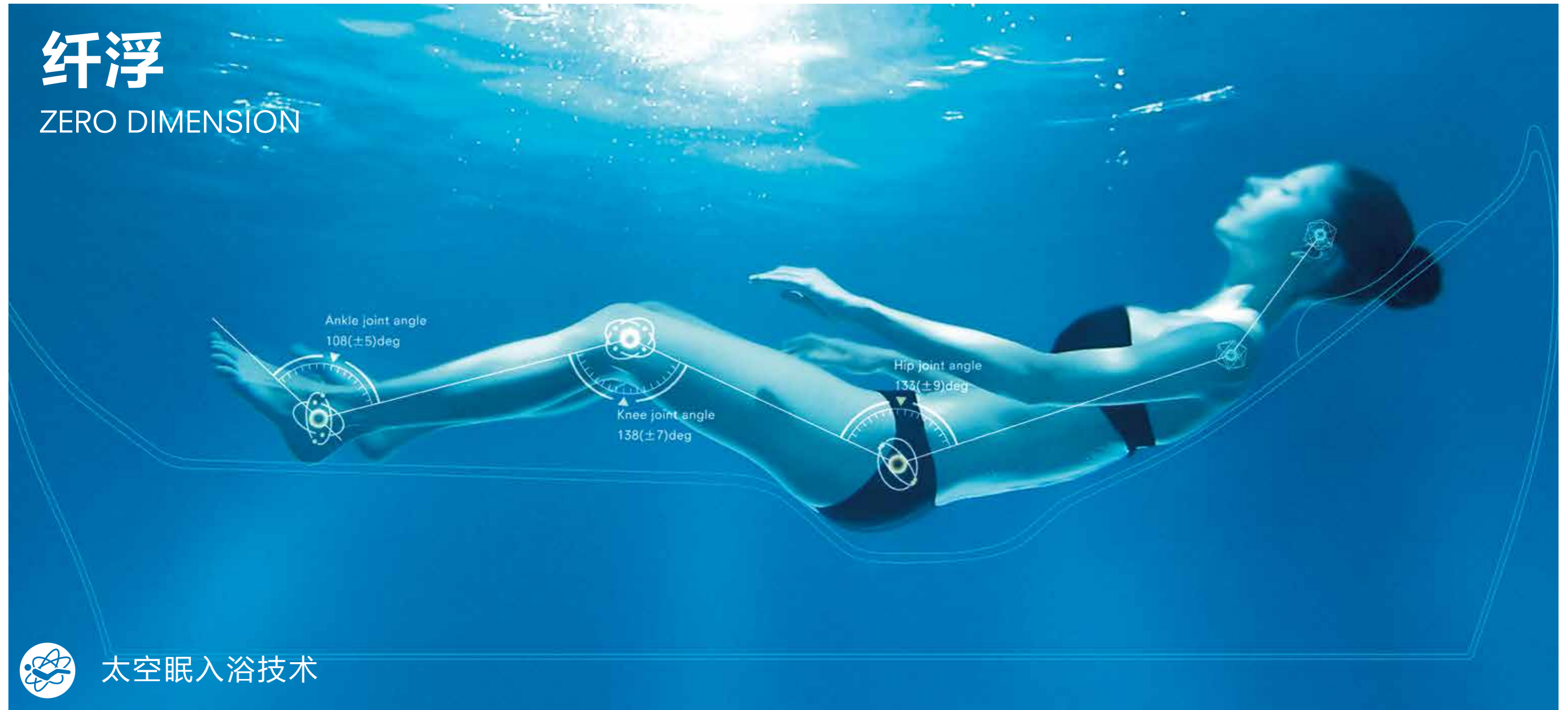

漂浮、平静，沉浸在冥想中的放松时刻。

宛如航天员在宇宙空间站休息时的姿态。

太空眠入浴技术的入浴姿态使身体从重力中解放出来，有助于缓解压力，带给你放松与舒适。



PJYD2200PW#TBL (黑白拼色)(无扶手)
PJYD2200PW#GW (高光)(无扶手)

晶雅石材质气泡冲浪按摩浴缸
2200*1050*780mm
已安装排水金具
推荐搭配:
浴缸水嘴 / 阀体
TBP01301C/TBN01105B



纤浮

ZERO DIMENSION



 太空眠入浴技术

大脑处于平静、放松状态

水魔力

HYDROHANDS

 魔力按摩浴缸技术

强劲有力的水流，舒缓放松身心。

当您横躺，将头部放置于头枕上时，您将拥有被包裹般的舒适感受。整个身体从颈部到背部始终保持自然的S曲线，让您尽情放松。保持这样的仰浴姿势，可以带来更深层的舒适与享受。



与气泡按摩的区别

魔力按摩浴缸技术可以产生没有气泡的强劲水流，带给你如同按摩般的体验。

魔力按摩浴缸技术尤其在漂浮浴缸中能够发挥效力。太空眠入浴技术的入浴姿态让你的身心仿佛进入冥想状态，带有适度刺激的水力按摩更进一步促进深度放松。

其他功能

肩颈 SPA

枕头的位置可根据人体体型做相应调节以安定身心，让各种体型的人都能从颈部到肩膀享受温暖的入浴体验。



气泡按摩

富于变化的气泡水流从底部涌上来，包裹着身体，带来温馨、舒适的入浴感受。



LED 照明

浴缸底座周围在 LED 照明灯的映照下，呈现出梦幻般的氛围。

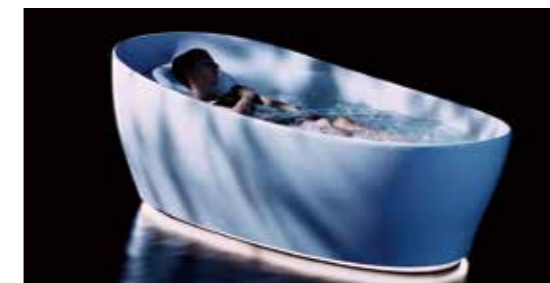

控制器

静电感应控制器只需轻轻触碰就能轻松操控。













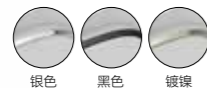

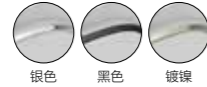
悠浮

RECLINE COMFORT

置身舒适之中，放松身心，进入舒缓的宁静状态。

当您横躺，将头部放置于头枕上时，您将拥有被包裹般的舒适感受。整个身体从颈部到背部始终保持自然的S曲线，让您尽情放松。保持这样的仰浴姿势，可以带来更深层的舒适与享受。

| | | |
|--|---|--|
|  | <p>PJY1744WPW#TBL (黑白拼色)(无扶手) PJY1744WHPW#GW (高光)(附扶手)(扶手银色) PJY1744BHPW#GWN (高光)(附扶手)(扶手黑色) PJY1744NHPW#GW (高光)(附扶手)(扶手镀铬) PJY1744WPW#GW (高光)(无扶手) PJY1744HPW#MW (哑光)(附扶手) PJY1744WPW#MW (哑光)(无扶手)</p> <p>颜色可选</p>  <p>银色 黑色 镀铬</p> | <p>晶雅石材质浴缸 1695*835*565mm 已安装脚踏式排水金具</p>  |
|  | <p>PJY1724WPW#TBL (黑白拼色)(无扶手) PJY1724WHPW#GW (高光)(附扶手)(扶手银色) PJY1724BHPW#GWN (高光)(附扶手)(扶手黑色) PJY1724NHPW#GW (高光)(附扶手)(扶手镀铬) PJY1724WPW#GW (高光)(无扶手) PJY1724HPW#MW (哑光)(附扶手) PJY1724WPW#MW (哑光)(无扶手)</p> <p>颜色可选</p>  <p>银色 黑色 镀铬</p> | <p>晶雅石材质浴缸 1700*800*565mm 已安装脚踏式排水金具</p>  |
|  | <p>PPY1750HP (珍珠白)(附扶手)(无裙边) PPY1750P (珍珠白)(无扶手)(无裙边)</p> <p>PPY1650HP (珍珠白)(附扶手)(无裙边) PPY1650P (珍珠白)(无扶手)(无裙边)</p> <p>PPY15B0HP (珍珠白)(附扶手)(无裙边) PPY15B0P (珍珠白)(无扶手)(无裙边)</p> | <p>珠光材质浴缸 1697*750*560mm 需另配排水金具</p>  <p>珠光材质浴缸 1600*750*560mm 需另配排水金具</p>  <p>珠光材质浴缸 1500*750*560mm 需另配排水金具</p>  |
|  | <p>PPY1780HP (珍珠白)(附扶手)(无裙边) PPY1780P (珍珠白)(无扶手)(无裙边)</p> <p>PPY15A0HP (珍珠白)(附扶手)(无裙边) PPY15A0P (珍珠白)(无扶手)(无裙边)</p> | <p>珠光材质浴缸 1697*750*560mm 需另配排水金具</p>  <p>珠光材质浴缸 1500*750*560mm 需另配排水金具</p>  |

悠浮

RECLINE COMFORT

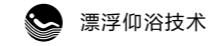

当您横躺，将头部放置于头枕上时，您将拥有被包裹般的舒适感受。

整个身体从颈部到背部始终保持自然的s曲线，让您尽情放松。保持这样的仰浴姿势，可以带来更深层的舒适与享受。

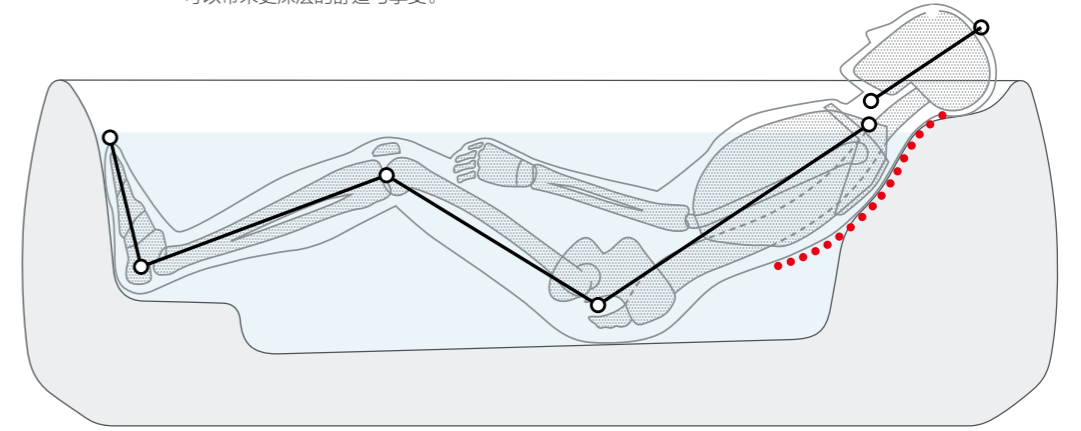

台阶设计

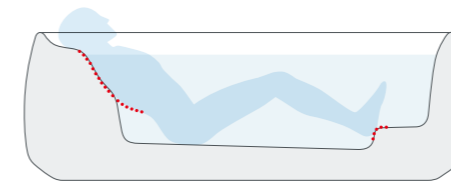

能让身材矮小的人群更加稳定安全地进入到浴缸中。

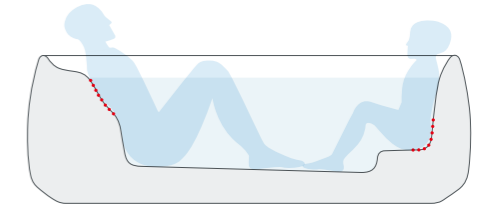

可以实现面对面的亲子入浴。

扶手设计

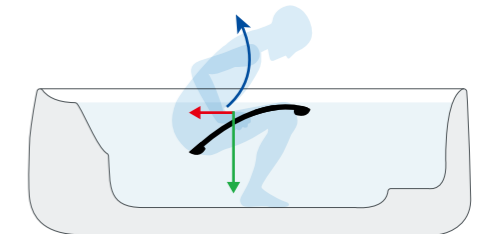
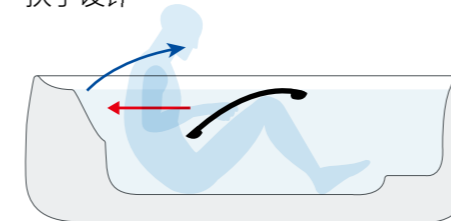

扶手角度的设计经过了深入研究，能帮助从仰面朝上的入浴姿势自然起身，握住站起时手腕、前臂都不需要非常过度的弯曲。

多种颜色, 随心选择

您可以选择类似于陶瓷的高光泽处理方式，或选择质地柔和的哑光处理方式。



高光



哑光



圆润大气，高贵与生俱来。TOTO 晶雅石材质系列，外观圆润大气，浑然天成，典雅气质弥漫始终。无论是浴缸还是洗脸盆，晶雅石材质系列为您的卫浴空间平添典雅、高贵。

PJY1414HPW#GW (高光)(附扶手)
PJY1414PW#GW (高光)(无扶手)

晶雅石材质浴缸
1400*800*650mm
已安装脚踏式排水金具
推荐搭配: 水嘴 DM334CFRR



PJY1514HPW#GW (高光)(附扶手)
PJY1514PW#GW (高光)(无扶手)

晶雅石材质浴缸
1500*800*650mm
已安装脚踏式排水金具
推荐搭配: 水嘴 DM334CFRR

PJY1614HPW#GW (高光)(附扶手)
PJY1614PW#GW (高光)(无扶手)

晶雅石材质浴缸
1600*800*665mm
已安装脚踏式排水金具
推荐搭配: 水嘴 DM334CFRR

PJY1814HPW#GW (高光)(附扶手)
PJY1814PW#GW (高光)(无扶手)

晶雅石材质浴缸
1800*900*665mm
已安装脚踏式排水金具
推荐搭配: 水嘴 DM334CFRR

尺寸的多样选择



1400*800*650mm



1500*800*650mm



1600*800*665mm



1800*900*665mm



PJYD2200PW#GW (高光)(无扶手)
PJYD2200PW#TBL (黑白拼色)(无扶手)

晶雅石材质气泡冲浪按摩浴缸
2200*1050*780mm
已安装排水金具
推荐搭配:
浴缸水嘴/ 阀体
TBP01301C/TBN01105B

浴缸颜色可选



red dot winner 2020



PJY608WZ#GW (高光)(无扶手) NEW

晶雅石材质浴缸
1600*750*565mm
已安装脚踏式排水金具
推荐搭配: 水嘴 DM334CFRR



PJY708WZ#GW (高光)(无扶手) NEW

晶雅石材质浴缸
1700*750*565mm
已安装脚踏式排水金具
推荐搭配: 水嘴 DM334CFRR



PJY618WZ#GW (高光)(无扶手) NEW

晶雅石材质浴缸
1600*795*650mm
已安装脚踏式排水金具
推荐搭配: 水嘴 DM334CFRR

PJY718WZ#GW (高光)(无扶手) NEW

晶雅石材质浴缸
1700*795*650mm
已安装脚踏式排水金具
推荐搭配: 水嘴 DM334CFRR

PJY1744WHPW#GW (高光)(附扶手)(扶手银色)
PJY1744BHPW#GWN (高光)(附扶手)(扶手黑色)
PJY1744NHPW#GW (高光)(附扶手)(扶手镀铬)
PJY1744WPW#GW (高光)(无扶手)
PJY1744WPW#TBL (黑白拼色)(无扶手)

晶雅石材质浴缸
1695*835*565mm
已安装脚踏式排水金具

扶手颜色可选

浴缸颜色可选



PJY1724WHPW#GW (高光)(附扶手)(扶手银色)
PJY1724BHPW#GWN (高光)(附扶手)(扶手黑色)
PJY1724NHPW#GW (高光)(附扶手)(扶手镀铬)
PJY1724WPW#GW (高光)(无扶手)
PJY1724WPW#TBL (黑白拼色)(无扶手)

晶雅石材质浴缸
1700*800*565mm
已安装脚踏式排水金具

扶手颜色可选

浴缸颜色可选



PJY1886HPW#GW (高光)(金色)(附扶手)
PJY1886HPW#MN#GW (高光)(银色)(附扶手)

晶雅石材质浴缸
1800*950*600mm
已安装按启式排水金具



PJY1734HPW#GW (高光)(附扶手)
PJY1734HPW#MW (哑光)(附扶手)
PJY1734PW#GW (高光)(无扶手)
PJY1734PW#MW (哑光)(无扶手)

晶雅石材质浴缸
1700*855*640mm
已安装脚踏式排水金具



PJY1604-4HPW#GW (高光)(附扶手)
PJY1604-4HPW#MW (哑光)(附扶手)

晶雅石材质浴缸
1650*1650*625mm
已安装脚踏式排水金具
推荐搭配:
水嘴 TBS01202C



PPY1606HPWG (金色)(附扶手)
PPY1606PWG (金色)(无扶手)

珠光材质浴缸
1600*800*645mm
已安装金属制排水金具

PPY1606HPWN (银色)(附扶手)
PPY1606PWN (银色)(无扶手)

珠光材质浴缸
1600*800*645mm
已安装金属制排水金具



PPY1610HIPTV14 (金色)(附扶手)
PPY1610HIPT (银色)(附扶手)

珠光材质浴缸
1600*810*700mm
已安装特制排水金具



PPY1750HP (珍珠白)(附扶手)(无裙边)
PPY1750P (珍珠白)(无扶手)(无裙边)

珠光材质浴缸
1697*750*560mm
需另配排水金具



PPY1650HP (珍珠白)(附扶手)(无裙边)
PPY1650P (珍珠白)(无扶手)(无裙边)

珠光材质浴缸
1600*750*560mm
需另配排水金具



PPY15B0HP (珍珠白)(附扶手)(无裙边)
PPY15B0P (珍珠白)(无扶手)(无裙边)

珠光材质浴缸
1500*750*560mm
需另配排水金具



PPY1780HP (珍珠白)(附扶手)(无裙边)
PPY1780P (珍珠白)(无扶手)(无裙边)

珠光材质浴缸
1697*750*560mm
需另配排水金具



PPY15A0HP (珍珠白)(附扶手)(无裙边)
PPY15A0P (珍珠白)(无扶手)(无裙边)

珠光材质浴缸
1500*750*560mm
需另配排水金具



PPY1590HP (附扶手)(无裙边)
PPY1590P (无扶手)(无裙边)

珠光材质浴缸
1500*750*595mm
需另配排水金具

PPY1740PW (无扶手)(无裙边)

珠光材质浴缸
1690*855*585mm
已安装排水金具



PPYB1610L/RHPT (附扶手)(无裙边)

珠光气泡按摩浴缸
1600*810*680mm
已安装排水金具

PPY1610HPT (附扶手)(无裙边)
PPY1610PT (无扶手)(无裙边)

珠光材质浴缸
1600*810*630mm
已安装排水金具





| | | |
|---|--|---|
|  | PPYD1930ZLHPWN (附扶手)(无裙边) PPYD1930ZRHPWN (附扶手)(无裙边) PPYD1930ZLPWN (无扶手)(无裙边) PPYD1930ZRPWN (无扶手)(无裙边) | 珠光气泡冲浪按摩浴缸 1900*950*650mm 已安装排水金具 |
| | PPYK1930ZLHPWN (附扶手)(无裙边) PPYK1930ZRHPWN (附扶手)(无裙边) PPYK1930ZLPWN (无扶手)(无裙边) PPYK1930ZRPWN (无扶手)(无裙边) | 珠光冲浪按摩浴缸 1900*950*650mm 已安装排水金具 |
| | PPYB1930ZLHPWN (附扶手)(无裙边) PPYB1930ZRHPWN (附扶手)(无裙边) PPYB1930ZLPWN (无扶手)(无裙边) PPYB1930ZRPWN (无扶手)(无裙边) | 珠光气泡按摩浴缸 1900*950*650mm 已安装排水金具 |
| | PPY1930HPWN (附扶手)(无裙边) PPY1930PWN (无扶手)(无裙边) | 珠光材质浴缸 1900*950*650mm 已安装排水金具 |

| | | |
|---|--|---------------------------------------|
|  | PPYK1570ZLHPN (附扶手)(无裙边) PPYK1570ZRHPN (附扶手)(无裙边) PPYK1570ZLPN (无扶手)(无裙边) PPYK1570ZRPN (无扶手)(无裙边) | 珠光冲浪按摩浴缸 1500*750*630mm 需另配排水金具 |
| | PPY1570HP (附扶手)(无裙边) PPY1570P (无扶手)(无裙边) | 珠光材质浴缸 1500*750*600mm 需另配排水金具 |
| | PPYK1770ZLHPN (附扶手)(无裙边) PPYK1770ZRHPN (附扶手)(无裙边) PPYK1770ZLPN (无扶手)(无裙边) PPYK1770ZRPN (无扶手)(无裙边) | 珠光冲浪按摩浴缸 1700*800*630mm 需另配排水金具 |
| | PPY1770P (无扶手)(无裙边) PPY1770HP (附扶手)(无裙边) | 珠光材质浴缸 1700*800*600mm 需另配排水金具 |

| | | |
|---|--|---------------------------------------|
|  | PPYK1560ZLHPN (附扶手)(无裙边) PPYK1560ZRHPN (附扶手)(无裙边) PPYK1560ZLPN (无扶手)(无裙边) PPYK1560ZRPN (无扶手)(无裙边) | 珠光冲浪按摩浴缸 1500*750*620mm 需另配排水金具 |
| | PPY1560HP (附扶手)(无裙边) PPY1560P (无扶手)(无裙边) | 珠光材质浴缸 1500*750*600mm 需另配排水金具 |
| | PPYK1760ZLHPN (附扶手)(无裙边) PPYK1760ZRHPN (附扶手)(无裙边) PPYK1760ZLPN (无扶手)(无裙边) PPYK1760ZRPN (无扶手)(无裙边) | 珠光冲浪按摩浴缸 1700*800*620mm 需另配排水金具 |
| | PPY1760HP (附扶手)(无裙边) PPY1760P (无扶手)(无裙边) | 珠光材质浴缸 1700*800*600mm 需另配排水金具 |

| | | |
|---|---|--|
|  | PPYD1720HPT (附扶手)(无裙边) PPYD1720PT (无扶手)(无裙边) | 珠光气泡冲浪按摩浴缸 (附彩灯) 1700*1700*600mm 已安装排水金具 |
| | PPYK1720HPT (附扶手)(无裙边) PPYK1720PT (无扶手)(无裙边) | 珠光冲浪按摩浴缸 1700*1700*600mm 已安装排水金具 |
| | PPYB1720HPT (附扶手)(无裙边) PPYB1720PT (无扶手)(无裙边) | 珠光气泡按摩浴缸 1700*1700*600mm 已安装排水金具 |
| | PPY1720HPT (附扶手)(无裙边) PPY1720PT (无扶手)(无裙边) | 珠光材质浴缸 1700*1700*600mm 已安装排水金具 |

| | | |
|---|------------------------|--|
|  | PPYD1630ZPT (无扶手)(无裙边) | 珠光气泡冲浪按摩浴缸 1600*1600*685mm 已安装排水金具 |
| | PPYK1630ZPT (无扶手)(无裙边) | 珠光冲浪按摩浴缸 1600*1600*685mm 已安装排水金具 |
| | PPYB1630ZPT (无扶手)(无裙边) | 珠光气泡按摩浴缸 1600*1600*685mm 已安装排水金具 |
| | PPY1630PT (无扶手)(无裙边) | 珠光材质浴缸 1600*1600*685mm 已安装排水金具 |

| | | |
|--|--|--|
|  | PPYD1543-3HPT (三孔龙头浴缸)(附扶手)(附裙边) PPYD1543-3PT (三孔龙头浴缸)(无扶手)(附裙边) PPYD1543-4HPT (四孔龙头浴缸)(附扶手)(附裙边) PPYD1543-4PT (四孔龙头浴缸)(无扶手)(附裙边) | 珠光气泡冲浪按摩浴缸 (附彩灯) 1500*1500*600mm 已安装排水金具 水嘴另配 |
| | PPYK1543-3HPT (三孔龙头浴缸)(附扶手)(附裙边) PPYK1543-3PT (三孔龙头浴缸)(无扶手)(附裙边) PPYK1543-4HPT (四孔龙头浴缸)(附扶手)(附裙边) PPYK1543-4PT (四孔龙头浴缸)(无扶手)(附裙边) | 珠光冲浪按摩浴缸 1500*1500*600mm 已安装排水金具 水嘴另配 |
| | PPYB1543-3HPT (三孔龙头浴缸)(附扶手)(附裙边) PPYB1543-3PT (三孔龙头浴缸)(无扶手)(附裙边) PPYB1543-4HPT (四孔龙头浴缸)(附扶手)(附裙边) PPYB1543-4PT (四孔龙头浴缸)(无扶手)(附裙边) | 珠光气泡按摩浴缸 1500*1500*600mm 已安装排水金具 水嘴另配 |
| | PPY1543-3HP (三孔龙头浴缸)(附扶手)(附裙边) PPY1543-3P (三孔龙头浴缸)(无扶手)(附裙边) PPY1543-4HP (四孔龙头浴缸)(附扶手)(附裙边) PPY1543-4P (四孔龙头浴缸)(无扶手)(附裙边) | 珠光材质浴缸 1500*1500*600mm 需另配水嘴、排水金具 |

| | | |
|---|---|--|
|  | PPYD1353-3HPT (三孔龙头浴缸)(附扶手)(附裙边) PPYD1353-3PT (三孔龙头浴缸)(无扶手)(附裙边) | 珠光气泡冲浪按摩浴缸 (附彩灯) 1350*1350*635mm 已安装排水金具 水嘴另配 |
| | PPYK1353-3HPT (三孔龙头浴缸)(附扶手)(附裙边) PPYK1353-3PT (三孔龙头浴缸)(无扶手)(附裙边) | 珠光冲浪按摩浴缸 1350*1350*635mm 已安装排水金具 水嘴另配 |
| | PPYB1353-3HPT (三孔龙头浴缸)(附扶手)(附裙边) PPYB1353-3PT (三孔龙头浴缸)(无扶手)(附裙边) | 珠光气泡按摩浴缸 1350*1350*635mm 已安装排水金具 水嘴另配 |
| | PPY1353-3HP (附扶手)(附裙边) PPY1353-3P (无扶手)(附裙边) | 珠光材质浴缸 1350*1350*635mm 需另配水嘴、排水金具 |

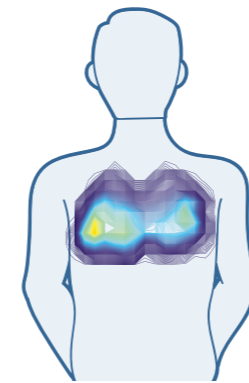

1 靠背的弧度设计

圆弧的靠背能在倚靠时让背部的受力分散，大面积的支撑带来高贴合感，实现更加舒适的入浴体验。

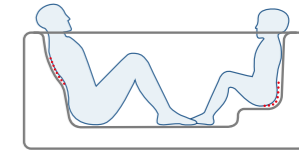
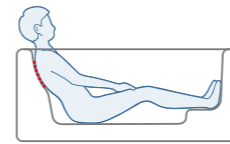

2 台阶设计

儿童可以安心落坐，也适合亲子共享入浴时光。

3 边缘扶手的设计

无论是进出浴缸，还是入浴时都能帮助支撑身体，让入浴过程更加安心、安全。



4 落坐处的设计

推荐以更为安定的坐姿进出浴缸。以坐姿配合边缘扶手进出浴缸能使过程中的动作量和速度减小，减少身体负担，减低跌倒风险。



5 收纳功能

侧面开放的收纳空间，可以放置多种洗浴用品和清洁用品，储物功能实用方便。毛巾杆的设计与浴缸外沿平行，既可避免不必要的磕碰，拿取也十分便利。



左右两种裙边设计

搭配专用的浴缸水嘴与排水金具，实现集多种功能于一身的的设计。

满足不同户型的布局要求，让小空间也能享受泡澡、舒适入浴。



TBG05301BA
铜合金台式单柄双控浴缸水嘴
(可转换、带手持花洒)



DB903S-2B
脚踏式排水金具
(含吐水功能)

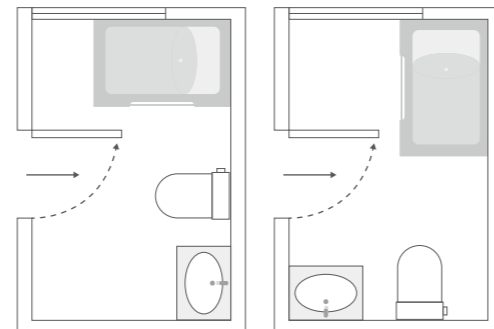

*户型图仅供参考



PAY1517-3LPF (附裙边)
PAY1517-3RPF (附裙边)



PAY1517LP (附裙边)
PAY1517RP (附裙边)



PAY1717CPTN (无扶手)(附裙边)

压克力浴缸
1700*750*540mm
已安装排水金具



PAY1720HP (附扶手)(无裙边)
PAY1720P (无扶手)(无裙边)

压克力浴缸
1700*800*575mm
需另配排水金具



PAY1517-3LPF (附裙边)
PAY1517-3RPF (附裙边)

压克力浴缸
1500*800*565mm
已安装脚踏式排水金具(含吐水功能)
需另购浴缸水嘴
推荐搭配:
浴缸水嘴 TBG05301BA



PAY1580HP (附扶手)(无裙边)
PAY1580P (无扶手)(无裙边)

压克力浴缸
1500*750*530mm
需另配排水金具



PAY1517LP (附裙边)
PAY1517RP (附裙边)

压克力浴缸
1500*800*565mm
需另配排水金具
推荐搭配:
排水金具 DB505R-2B



PAYK1750ZLHP (附扶手)(无裙边)
PAYK1750ZRHP (附扶手)(无裙边)
PAYK1750ZLP (无扶手)(无裙边)
PAYK1750ZRP (无扶手)(无裙边)

压克力按摩浴缸
1700*800*565mm
需另配排水金具

PAY1750HP (附扶手)(无裙边)
PAY1750P (无扶手)(无裙边)
PAY1753HP (附扶手)(附裙边)
PAY1753P (无扶手)(附裙边)

压克力浴缸
1700*800*555mm
需另配排水金具

PAYK1550ZLHP (附扶手)(无裙边)
PAYK1550ZRHP (附扶手)(无裙边)
PAYK1550ZLP (无扶手)(无裙边)
PAYK1550ZRP (无扶手)(无裙边)

压克力按摩浴缸
1500*750*565mm
需另配排水金具

PAY1550HP (附扶手)(无裙边)
PAY1550P (无扶手)(无裙边)

压克力浴缸
1500*750*555mm
需另配排水金具



PAY17A0HP (附扶手)(无裙边)
PAY17A0P (无扶手)(无裙边)

压克力浴缸
1700*750*467mm
需另配排水金具



PAY1513P (无扶手)(附裙边)

压克力浴缸
1500*700*416mm
需另配排水金具

PAY1510P (无扶手)(无裙边)

压克力浴缸
1500*700*410mm
需另配排水金具

PAY1520P (无扶手)(无裙边)



亚克力浴缸
1500*750*470mm
需另配排水金具

PAY1700P (无扶手)(无裙边)



亚克力浴缸
1700*800*530mm
需另配排水金具

PAY1600P (无扶手)(无裙边)



亚克力浴缸
1600*800*530mm
需另配排水金具

PAY1320P (无扶手)(无裙边)



亚克力浴缸
1350*750*470mm
需另配排水金具

PAYK1300ZP (无扶手)(无裙边)



亚克力按摩浴缸
1300*1300*545mm
需另配排水金具

PAY1300P (无扶手)(无裙边)



亚克力浴缸
1300*1300*545mm
需另配排水金具

P10L T968PA (无扶手)(附裙边)
(进口品)



玻璃纤维增强树脂浴缸
800*700*645mm

P10R T968PA (无扶手)(附裙边)
(进口品)



P124L T968PA (无扶手)(附裙边)
(进口品)



玻璃纤维增强树脂浴缸
1020*740*645mm

P124R T968PA (无扶手)(附裙边)
(进口品)



P164L T968PA (无扶手)(附裙边)
(进口品)



玻璃纤维增强树脂浴缸
1200*685*550mm

P164R T968PA (无扶手)(附裙边)
(进口品)



DB505R-1A/B (直排/横排)
DB505R-2A/B (直排/横排)
DB505R-3A/B (直排/横排)



按启式浴缸排水

DB504S-1A/B (直排/横排)
DB504S-2A/B (直排/横排)
DB504S-3A/B (直排/横排)



按启式浴缸排水

DB601N2-1A/B (直排/横排)
DB601N2-2A/B (直排/横排)
DB601N2-3A/B (直排/横排)



脚踏式浴缸排水

DB602N2-1A/B (直排/横排)
DB602N2-2A/B (直排/横排)
DB602N2-3A/B (直排/横排)





脚踏式浴缸排水

DB903S-1A/B (直排/横排)
DB903S-2A/B (直排/横排)
DB903S-3A/B (直排/横排)



脚踏式浴缸排水(含吐水功能)

* 可搭配TOTO所有型号浴缸

| | |
|---|----------------------------------|
|  | <p>NTP016#SK (天空蓝) 浴缸头枕</p> |
|  | <p>NTP016#CH (巧克力棕) 浴缸头枕</p> |
|  | <p>NTP016#LO (亮橙) 浴缸头枕</p> |

| | 珠光 | 压克力 | | |
|-----------------------|--|--|--|-----------|
| 浴缸品番 | PPY1353-3P/HP PPY1560P/HP PPYK1560ZL/RHPN PPYK1560ZL/RPN PPY1570P/HP PPYK1570ZL/RHPN PPYK1570ZL/RPN PPY1760P/HP PPYB1760ZL/RHP PPYB1760ZL/RP PPYK1760ZL/RHPN PPYK1760ZL/RPN PPY1770P/HP PPYB1770ZL/LHP PPY1543-3/4P PPY1543-3/4HP PPYK1770ZL/RPN PPYK1770ZL/RHPN PPY1590P/HP | PAY1320P PAY1510P/1513P PAY1520P | PAY1300P PAYK1300ZP PAY1580P/HP PAY1600P PAY1700P PAY1720P/HP PAY1560P/HP PAY1550P/HP PAYK1550ZR/LP PAYK1550ZR/LHP PAY1750P/HP PAY1753P/HP PAYK1750ZR/LP PAYK1750ZR/LHP PAY17A0P/HP PAY1517L/RP | PAY1710CP |
| 排水金具品番 | | | | |
| DB505R-○ 按启式浴缸用排水 | | | | |
| DB504S-○ 按启式浴缸用排水 | | | | |
| DB601N2-○ 脚踏式浴缸用排水 | 2A/B | 1A/B | 2A/B | 3A/B |
| DB602N2-○ 脚踏式浴缸用排水 | | | | |

| | 珠光 | 压克力 | |
|---------------------------------|---|-------------------------------------|--|
| 浴缸品番 | PPY1560P/HP PPYK1560ZL/RHPN PPYK1560ZL/RPN PPY1570P/HP PPYK1570ZL/RHPN PPYK1570ZL/RPN PPY1760P/HP PPYK1760ZL/RHPN PPYK1760ZL/RPN PPY1770P/HP PPYK1770ZL/RHPN PPYK1770ZL/RPN PPY1590P/HP PPY15A0P/HP PPY1580P/HP PPY1650P/HP PPY1750P/HP | PAY1320P PAY1510P/HP PAY1520P | PAY1300P PAYK1300ZP PAY1580P/HP PAY1600P PAY1700P PAY1720P/HP PAYK1720ZL/RHP PAYK1720ZL/RP PAY1550P/HP PAYK1550ZL/RHP PAYK1550ZL/RP PAY1750P/HP PAYK1750ZR/LHP PAYK1750ZR/LP PAY17A0P/HP |
| 排水金具品番 | | | |
| DB903S-○ 脚踏式浴缸用排水 (含吐水功能) | 2A/B | 1A/B | 2A/B |

PUBLIC

推荐组合 RECOMMEND PRODUCTS



自动感应水嘴



TLE24003C1(交流电)
TLE24003C2(干电池)
TLE24003C3(水力发电)
TLE24003C6(电热水器)
(机能部, 排水另购)
自动感应水嘴(1.3L)



LW1705B
桌上式洗面器
550*380*125mm



TLE27001C1(交流电)
TLE27001C2(干电池)
TLE27001C3(水力发电)
TLE27001C6(电热水器)
(机能部, 排水另购)
自动感应水嘴(1.3L)



TLK08001B(交流电, 机能部另购)
自动感应皂液器(进口品)

LW1536B
台下式洗面器
590*380mm



TLE28001C1(交流电)
TLE28001C2(干电池)
TLE28001C3(水力发电)
TLE28001C6(电热水器)
(机能部, 排水另购)
自动感应水嘴(1.3L)



TLK07001B(交流电, 机能部另购)
自动感应皂液器(进口品)

LW1506B
台下式洗面器
590*380mm



小便器



USWN900B(干电池)
USWN900BE(交流电)
USWN900BS(电解除菌水)
壁挂式节水型自动感应小便器
冲水量: 0.5L
380*420*920mm



USWN902B(干电池)
USWN902BE(交流电)
USWN902BS(电解除菌水)
壁挂式节水型自动感应小便器
冲水量: 0.5L
380*390*660mm



USWN927B(干电池)
USWN927BE(交流电)
USWN927BS(电解除菌水)
壁挂式节水型自动感应小便器
冲水量: 0.5L
260*330*590mm



大便器



TREF75U2C(交流电)
3.3/4.8L 感应式大便冲洗阀
185*185mm(感应器)

CW822EB-75U2

壁挂式冲洗阀坐便器
540*380*335mm
EcoMAX DUAL 3.3/4.8L
推荐搭配:
卫洗丽®TCF3G460KCN
WH005B(支架, 后排水管)
HP511P(支架用下排水管)
TEP002(砂浆用固定配件)



TREF75U2C(交流电)
3.3/4.8L 感应式大便冲洗阀
185*185mm(感应器)

CW553B-75U2
CW553EB-75U2

壁挂式冲洗阀坐便器
540*380*335mm
EcoMAX DUAL 3.3/4.8L
推荐搭配:
卫洗丽®TCF34570GCN(搭配CW553EB)
WH005B(支架, 后排水管)
HP511P(支架用下排水管)
TEP002(砂浆用固定配件)



阵容丰富



多种尺寸

可根据需求，搭配不同高度的洗面器

● 高度



标准款+台下式洗面器



中款+桌上式洗面器



高款+桌上式洗面器

● 长度



标准款+桌上式洗面器



长款+桌上式洗面器

舒适使用

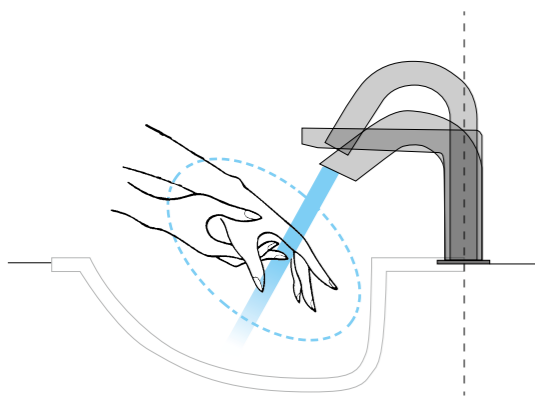

全程免触感应更为安心

精心设计，减少溅水烦恼

水嘴与洗面器的距离经过多次实验，精心设计。无论搭配何款 TOTO 洗面器，感应落水点都几乎一致。这样既能保证使用时的舒适，也不用担心溅水。



电解除菌



智净

EWATER+

电解除菌技术

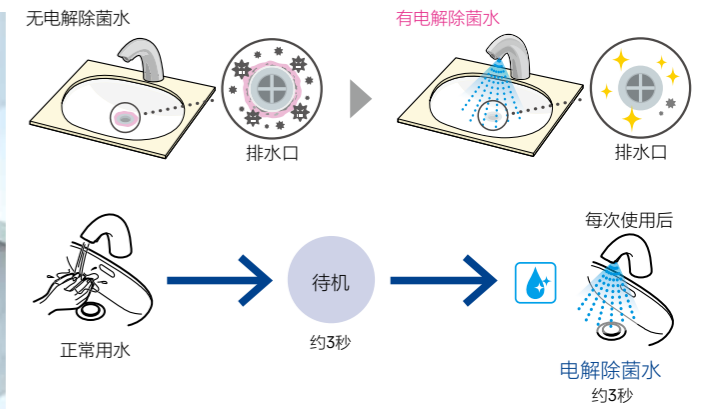

每次使用后，自动感应水嘴会自动待机3秒左右，期间如果没有感应到有人继续使用，水嘴将针对排水口，自动喷洒约3秒的电解除菌水，从而有效抑制排水口周边的细菌繁殖，保持洗面器的清洁。

*LED 光线仅表示电解除菌水喷洒时的效果，实际使用时无灯光。

其他技术



纤雨

SOFT FLOW

水嘴柔和出水技术

出水细腻优雅，形状优美，实现柔和触感的同时，也带来赏心悦目的视觉享受。



ECO CAP

水嘴气泡吐水技术

在水流中混入空气，出水顺畅、劲中带柔。节水的同时，带来更加舒适的感受。



ECOPOWER

水力发电技术

每次使用，水流会通过内置的微型叶轮机，叶轮机高速旋转产生的能量会转化为电力被储存，以此保证水嘴日常的运转。



WATER SAVING

节水技术

1.3L/MIN的流量，实现节水的同时，也能保证舒适的使用感。

感应灵敏

高敏感度、高舒适感

前端搭载小型感应器

拥有较高的耐干扰性，可以准确捕捉手部动作，提升使用的舒适度。

可适用于各类材质的洗面器

感应器内置偏光滤镜

可以屏蔽多余的反射光线，有效避免误操作。

对于使用环境具有自动识别功能

感应器拥有自动识别功能

可以自动调节感应距离，识别静态物体，施工方便、省时省力。





- 镀铬
- 拉丝镀铬

TLP01701C4 (镀铬)
TLP01701C4#BN (拉丝镀铬)
TLP01702B1 (控制器部)
(进口品)

自动感应水嘴 (3L)
排水另购
推荐搭配:
洗面器 LW4706B



TLE21001C1(交流电)
TLE21001C2(干电池)
TLE21001C3(水力发电)
TLE21001C6(电热水器)
(机部部, 排水另购)(进口品)

自动感应水嘴 (1.3L)
可搭配电热水机部部或 SMA 恒温阀



TLE20001C1(交流电)
TLE20001C2(干电池)
TLE20001C3(水力发电)
TLE20001C6(电热水器)
(机部部, 排水另购)(进口品)

自动感应水嘴 (1.3L)
可搭配电热水机部部或 SMA 恒温阀



TLE22001C1(交流电)
TLE22001C2(干电池)
TLE22001C3(水力发电)
TLE22001C6(电热水器)
(机部部, 排水另购)
(进口品)

自动感应水嘴 (1.3L)
可搭配电热水机部部或 SMA 恒温阀



| | | | | |
|---|---|---|--|--|
|  TLE23001C1(交流电) TLE23001C2(干电池) TLE23001C3(水力发电) TLE23001C6(电热水器) (机部部, 排水另购) 自动感应水嘴 (1.3L) 可搭配电热水机部部或 SMA 恒温阀   |  TLE23002C1(交流电) TLE23002C2(干电池) TLE23002C3(水力发电) TLE23002C6(电热水器) (机部部, 排水另购) 自动感应水嘴 (1.3L) 可搭配电热水机部部或 SMA 恒温阀   |  TLE23003C1(交流电) TLE23003C2(干电池) TLE23003C3(水力发电) TLE23003C6(电热水器) (机部部, 排水另购) 自动感应水嘴 (1.3L) 可搭配电热水机部部或 SMA 恒温阀   |  TLE23004C1(交流电) TLE23004C2(干电池) TLE23004C3(水力发电) TLE23004C6(电热水器) (机部部, 排水另购) 自动感应水嘴 (1.3L) 可搭配电热水机部部或 SMA 恒温阀  |  TLE23005C1(交流电) TLE23005C2(干电池) TLE23005C3(水力发电) TLE23005C6(电热水器) (机部部, 排水另购) 自动感应水嘴 (1.3L) 可搭配电热水机部部或 SMA 恒温阀  |
|---|---|---|--|--|

| | | | | |
|---|---|---|--|--|
|  TLE24001C1(交流电) TLE24001C2(干电池) TLE24001C3(水力发电) TLE24001C6(电热水器) (机部部, 排水另购) 自动感应水嘴 (1.3L) 可搭配电热水机部部或 SMA 恒温阀   |  TLE24002C1(交流电) TLE24002C2(干电池) TLE24002C3(水力发电) TLE24002C6(电热水器) (机部部, 排水另购) 自动感应水嘴 (1.3L) 可搭配电热水机部部或 SMA 恒温阀   |  TLE24003C1(交流电) TLE24003C2(干电池) TLE24003C3(水力发电) TLE24003C6(电热水器) (机部部, 排水另购) 自动感应水嘴 (1.3L) 可搭配电热水机部部或 SMA 恒温阀   |  TLE24004C1(交流电) TLE24004C2(干电池) TLE24004C3(水力发电) TLE24004C6(电热水器) (机部部, 排水另购) 自动感应水嘴 (1.3L) 可搭配电热水机部部或 SMA 恒温阀  |  TLE24005C1(交流电) TLE24005C2(干电池) TLE24005C3(水力发电) TLE24005C6(电热水器) (机部部, 排水另购) 自动感应水嘴 (1.3L) 可搭配电热水机部部或 SMA 恒温阀  |
|---|---|---|--|--|



TLE25001C1(交流电)
TLE25001C2(干电池)
TLE25001C3(水力发电)
TLE25001C6(电热水器)
(机能部, 排水另购)

自动感应水嘴 (1.3L)
可搭配电热水机部或
SMA 恒温阀



reddot winner 2021

TLE25002C1(交流电)
TLE25002C2(干电池)
TLE25002C3(水力发电)
TLE25002C6(电热水器)
(机能部, 排水另购)

自动感应水嘴 (1.3L)
可搭配电热水机部或
SMA 恒温阀



reddot winner 2021

TLE25003C1(交流电)
TLE25003C2(干电池)
TLE25003C3(水力发电)
TLE25003C6(电热水器)
(机能部, 排水另购)

自动感应水嘴 (1.3L)
可搭配电热水机部或
SMA 恒温阀



reddot winner 2021

TLE25004C1(交流电)
TLE25004C2(干电池)
TLE25004C3(水力发电)
TLE25004C6(电热水器)
(机能部, 排水另购)

自动感应水嘴 (1.3L)
可搭配电热水机部或
SMA 恒温阀



TLE25005C1(交流电)
TLE25005C2(干电池)
TLE25005C3(水力发电)
TLE25005C6(电热水器)
(机能部, 排水另购)

自动感应水嘴 (1.3L)
可搭配电热水机部或
SMA 恒温阀





TLE26001C1(交流电)
TLE26001C2(干电池)
TLE26001C3(水力发电)
TLE26001C6(电热水器)
(机能部, 排水另购)

自动感应水嘴 (1.3L)
可搭配电热水机部或
SMA 恒温阀



reddot winner 2021

TLE26002C1(交流电)
TLE26002C2(干电池)
TLE26002C3(水力发电)
TLE26002C6(电热水器)
(机能部, 排水另购)

自动感应水嘴 (1.3L)
可搭配电热水机部或
SMA 恒温阀



reddot winner 2021

TLE26003C1(交流电)
TLE26003C2(干电池)
TLE26003C3(水力发电)
TLE26003C6(电热水器)
(机能部, 排水另购)

自动感应水嘴 (1.3L)
可搭配电热水机部或
SMA 恒温阀



reddot winner 2021

TLE26004C1(交流电)
TLE26004C2(干电池)
TLE26004C3(水力发电)
TLE26004C6(电热水器)
(机能部, 排水另购)

自动感应水嘴 (1.3L)
可搭配电热水机部或
SMA 恒温阀



TLE26005C1(交流电)
TLE26005C2(干电池)
TLE26005C3(水力发电)
TLE26005C6(电热水器)
(机能部, 排水另购)

自动感应水嘴 (1.3L)
可搭配电热水机部或
SMA 恒温阀





TLE30001C5(交流电)
(机能部, 排水另购)(进口品)

自动感应水嘴 (1.3L)
带电解除菌水
可搭配 SMA 恒温阀



TLE31001C5(交流电)
(机能部, 排水另购)(进口品)

自动感应水嘴 (1.3L)
带电解除菌水
可搭配 SMA 恒温阀



DLE124BSK(干电池)
DLE124BE(交流电)
附机能部

自动感应水嘴 (2.0L) 单冷



TLE27001C1(交流电)
TLE27001C2(干电池)
TLE27001C3(水力发电)
TLE27001C6(电热水器)
(机能部, 排水另购)

自动感应水嘴 (1.3L)
无电解除菌水
可搭配电热水机部或 SMA 恒温阀



TLE28001C1(交流电)
TLE28001C2(干电池)
TLE28001C3(水力发电)
TLE28001C6(电热水器)
(机能部, 排水另购)

自动感应水嘴 (1.3L)
无电解除菌水
可搭配电热水机部或 SMA 恒温阀





TLK07001B(交流电)
机能部另购
(进口品)
自动感应皂液器
100-240V

TLK08001B(交流电)
机能部另购
(进口品)
自动感应皂液器
100-240V



DSE101E(交流电)
附机能部
自动感应皂液器
100-240V

DSE101K(干电池)
附机能部
自动感应皂液器
4节1.5V碱性1号干电池

DSE102E(交流电)
附机能部
自动感应皂液器
100-240V

DSE103E(交流电)
附机能部
自动感应皂液器
100-240V

*仅TLE25001C系列, TLE25003C系列, TLE25005C系列,
TLE26001C系列, TLE26002C系列
可对应颜色 (#BN、#PFG、#PBR、#MBL、#BBR)

感应水嘴与机能部搭配表

| 水嘴型号 | 单冷 | | | 恒温 | | | 单冷(除菌) | 恒温(除菌) | 电热水器机能部 | 皂液器机能部 | | |
|-------------|-----------|-----------|-----------|----------------------------------|----------------------------------|----------------------------------|-----------|----------------------------------|------------|-------------------------|-------------------------|-------------------------|
| | 水力发电 | 交流电 | 干电池 | 水力发电 | 交流电 | 干电池 | 交流电 | 交流电 | 交流电 | 交流电 | 交流电 | 交流电 |
| | TLE03501B | TLE01501B | TLE04501B | TLE03501B+ TLE05701B (SMA) | TLE01501B+ TLE05701B (SMA) | TLE04501B+ TLE05701B (SMA) | TLE02501B | TLE02501B+ TLE05701B (SMA) | REAH03B2CR | TLK01101BA (适配1个吐皂口) | TLK01102BA (适配2个吐皂口) | TLK01103BA (适配3个吐皂口) |
| TLE20001C系列 | ● | ● | ● | ● | ● | ● | — | — | ● | — | — | — |
| TLE21001C系列 | ● | ● | ● | ● | ● | ● | — | — | ● | — | — | — |
| TLE22001C系列 | ● | ● | ● | ● | ● | ● | — | — | ● | — | — | — |
| TLE23001C系列 | ● | ● | ● | ● | ● | ● | — | — | ● | — | — | — |
| TLE23002C系列 | ● | ● | ● | ● | ● | ● | — | — | ● | — | — | — |
| TLE23003C系列 | ● | ● | ● | ● | ● | ● | — | — | ● | — | — | — |
| TLE23004C系列 | ● | ● | ● | ● | ● | ● | — | — | ● | — | — | — |
| TLE23005C系列 | ● | ● | ● | ● | ● | ● | — | — | ● | — | — | — |
| TLE24001C系列 | ● | ● | ● | ● | ● | ● | — | — | ● | — | — | — |
| TLE24002C系列 | ● | ● | ● | ● | ● | ● | — | — | ● | — | — | — |
| TLE24003C系列 | ● | ● | ● | ● | ● | ● | — | — | ● | — | — | — |
| TLE24004C系列 | ● | ● | ● | ● | ● | ● | — | — | ● | — | — | — |
| TLE24005C系列 | ● | ● | ● | ● | ● | ● | — | — | ● | — | — | — |
| TLE25001C系列 | ● | ● | ● | ● | ● | ● | — | — | ● | — | — | — |
| TLE25002C系列 | ● | ● | ● | ● | ● | ● | — | — | ● | — | — | — |
| TLE25003C系列 | ● | ● | ● | ● | ● | ● | — | — | ● | — | — | — |
| TLE25004C系列 | ● | ● | ● | ● | ● | ● | — | — | ● | — | — | — |
| TLE25005C系列 | ● | ● | ● | ● | ● | ● | — | — | ● | — | — | — |
| TLE26001C系列 | ● | ● | ● | ● | ● | ● | — | — | ● | — | — | — |
| TLE26002C系列 | ● | ● | ● | ● | ● | ● | — | — | ● | — | — | — |
| TLE26003C系列 | ● | ● | ● | ● | ● | ● | — | — | ● | — | — | — |
| TLE26004C系列 | ● | ● | ● | ● | ● | ● | — | — | ● | — | — | — |
| TLE26005C系列 | ● | ● | ● | ● | ● | ● | — | — | ● | — | — | — |
| TLE27001C系列 | ● | ● | ● | ● | ● | ● | — | — | ● | — | — | — |
| TLE28001C系列 | ● | ● | ● | ● | ● | ● | — | — | ● | — | — | — |
| TLE30001C5 | — | — | — | — | — | — | ● | ● | — | — | — | — |
| TLE31001C5 | — | — | — | — | — | — | ● | ● | — | — | — | — |
| TLK07001B | — | — | — | — | — | — | — | — | — | ● | ● | ● |
| TLK08001B | — | — | — | — | — | — | — | — | — | ● | ● | ● |



舒适
COMFORTABLE

迅速供热，舒适洗手。
与锅炉供热水相比配管更短，减少热量的散发，更节能、环保。
适用于各种公共场所商务楼、百货商场、医院、社会福利场所等

耐久性 & 安全
DURABILITY&SAFETY

不锈钢材质的水箱经久耐用，卫生安全。
40人连续使用，水温不变，将水加热并储存，与冷水混合后提供舒适的温水，可以供40人连续使用，并且保持水温。(5秒/人)

安装简便
INSTALLATION

配备电源和供水配管后，就能进行安装。
安装后很快便能提供热水。

环保
ECOLOGY

采用了泡沫吐水及电磁阀控制系统，可及时开启、关闭龙头，并可根据每天的使用频率，自动调节加热的水温，节能环保。
机盒面积相当于普通A4大小的复印纸，安装在台面下方，不仅轻便而且小巧、美观。



REAH03B2CR
(进口品)

自动感应水嘴用小型电热水器 (控制部)
电热水感应水嘴机能部
210*130*297mm

内部构造与安全设计

混合阀芯
由于水箱中经加热的水需和管道供水混合并达到适当温度后再使用，所以即使贮存的热水量较少，也能充分的供应。

电磁阀
根据感应口的感应，阀芯进行开、闭。热水自动出、止。

温度调节旋钮

水箱
不锈钢材质的水箱，不但耐用，更使用安全。

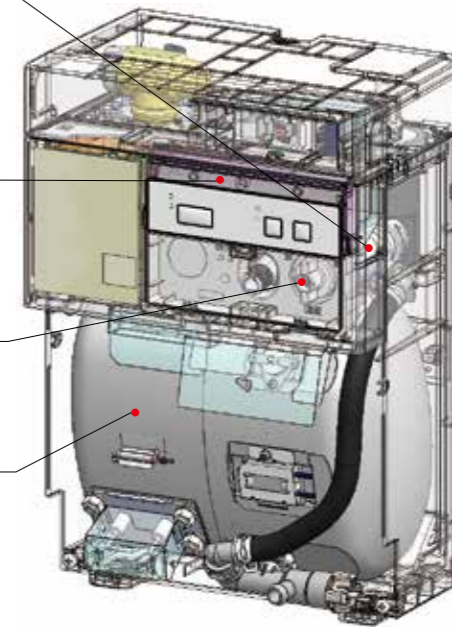

6重安全设计

- 防高温出水装置
- 防过热装置
热敏电阻故障时安全停止
 - 热敏电阻
防止加热器空烧
 - 温度保险丝
热敏电阻、防过热装置故障时安全停止
- 防火装置
- 电流保险丝
电流过大时安全停止
 - 防延烧外壳
采用不易燃材料，防止延烧
 - 防滴水外壳
防止电装部件被溅水

智能节电示意图

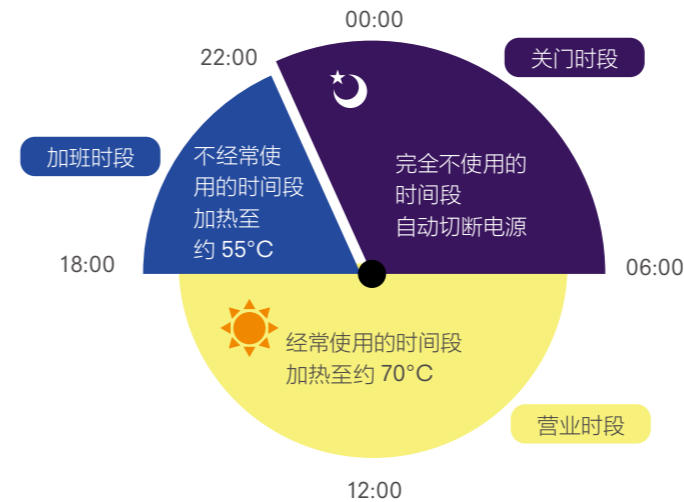

适用于各种公共场所如商务楼、百货商场、医院、社会福利场所等。

轻便小巧，使用方便



设计人性，考虑周全，即使是特殊人群也不影响他们的使用



Double flush 3.3/4.8L



全新设计

- 无边框设计
- 优雅的金属表面加工
- 与模塑件融合的感应窗
- 大冲洗按键，便于轻使用
- 185x185mm

水量恒定技术



当水压波动时，通过定流量阀的伸缩，自动调节水量和水势，减少干扰影响，保持水量恒定。

※进水要求：0.1MPa(动压)-0.75MPa(静压) (此技术仅限 TREF75U2C 和 TREF75K2C)

集成面板，简易安装



一体式集成面板，设计升级简化安装。

自我学习功能

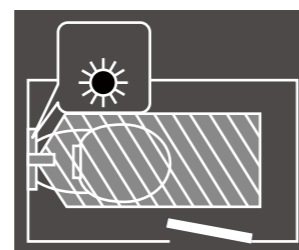

初始安装期间无需调节阀门。自动调节隔间内的反射防止误感应。

高效冲洗

360° 漩涡式冲洗技术



360°漩涡式冲洗技术在确保高效冲洗的同时，还实现了节水，静音。强劲的水流形成 360 度旋转，全方位冲洗无棱内壁。

内壁易洁结构设计



特别的无棱内壁设计，让污垢、细菌难以藏身，更重要的是打扫坐便器变得更为轻松。

纳米抗污釉面技术

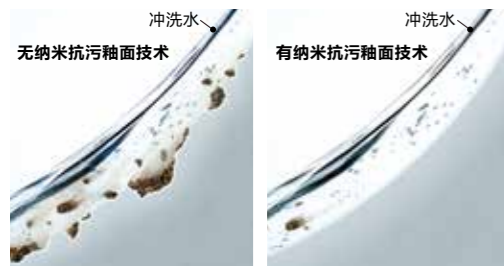

减少容易藏污纳垢的陶瓷表面凹凸。采用纳米抗污技术的釉面空隙小于纳米水平，几乎不给污垢容身的空间。

冲洗时坐便器表面的断面放大示意图



CW553B-75U2
CW553EB-75U2

壁挂式冲洗阀坐便器
540*380*335mm
EcoMAX DUAL 3.3/4.8L 节水

智能洁净系统

推荐搭配：
卫洗丽®TCF34570GCN (搭配 CW553EB)
感应式冲洗阀 TREF75U2C (交流电)
WH005B (支架、后排水管)
HP511P (支架用下排水管)
TEP002 (砂浆用固定配件)



TREF75U2C (交流电)
3.3/4.8L 感应式大便器冲洗阀
185*185mm (感应器)



CW582EB-75U2
CW582EB-75K2

壁挂式冲洗阀坐便器
540*380*335mm
EcoMAX DUAL 3.3/4.8L 节水

智能洁净系统

推荐搭配：
感应式冲洗阀 TREF75K2C (干电池)
TREF75U2C (交流电)
WH005B (支架、后排水管)
HP511P (支架用下排水管)
TEP002 (砂浆用固定配件)



TREF75K2C (干电池)
TREF75U2C (交流电)
3.3/4.8L 感应式大便器冲洗阀
185*185mm (感应器)



CW822EB-75U2

壁挂式冲洗阀坐便器
540*380*335mm
EcoMAX DUAL 3.3/4.8L 节水

智能洁净系统

推荐搭配：
卫洗丽®TCF3G460KCN
WH005B (支架、后排水管)
HP511P (支架用下排水管)
TEP002 (砂浆用固定配件)



TREF75U2C (交流电)
3.3/4.8L 感应式大便器冲洗阀
185*185mm (感应器)



CW7FVB

蹲便器
620*275*437mm
8L

推荐搭配：
感应式冲洗阀 TREF85K2CA (干电池)
TREF85U2CA (交流电)
大便器冲洗阀 DC603-1VLC
DC603VLC
DCB603VC



TREF85K2CA (干电池)
TREF85U2CA (交流电)
8.0L 感应式大便器冲洗阀
185*185mm (感应器)



CW11B

蹲便器
590*400*290mm

推荐搭配：
感应式冲洗阀 6L TREF65K2C (干电池)
TREF65U2C (交流电)
水箱 6L
大便器冲洗阀 8L DC603VLC
DC603VLC
DCB603VC

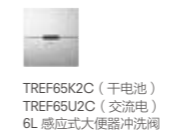

TREF65K2C (干电池)
TREF65U2C (交流电)
6L 感应式大便器冲洗阀
185*185mm (感应器)



CW763FVB (坑距 200mm)
CW763FVPB (H=180mm)



DCE602U (干电池)
DCE602UE (交流电)
4.6L 隐藏式感应冲洗阀

落地式冲洗阀坐便器
630*380*483mm
EcoMAX 4.6L 节水
推荐搭配:
感应式冲洗阀 DCE602U (干电池)
DCE602UE (交流电)



CW7FVB

蹲便器
620*275*437mm
8L
推荐搭配:
感应式冲洗阀 TREF85K2CA (干电池)
TREF85U2CA (交流电)
大便器冲洗阀 DC603-1VLFC
DC603VLC
DCB603VC



CW7RB/SW570RB

蹲便器 / 水箱
蹲便器: 620*275*437mm
蹲便器用水箱: 316*316*425mm
6L



USWN900B (干电池)
USWN900BE (交流电)
USWN900BS (电解除菌水)
壁挂式节水型自动感应小便器
冲水量: 0.5L
380*420*920mm



USWN902B (干电池)
USWN902BE (交流电)
USWN902BS (电解除菌水)
壁挂式节水型自动感应小便器
冲水量: 0.5L
380*390*660mm



NEW
USWN927B (干电池)
USWN927BE (交流电)
USWN927BS (电解除菌水)
壁挂式节水型自动感应小便器
冲水量: 0.5L
260*330*590mm



USWN810B (干电池)
USWN810BE (交流电)
壁挂式节水型自动感应小便器
冲水量: 1.5L
390*380*1020mm



UWN901HB (后进水)
壁挂式节水型小便器
380*420*920mm
感应器另配
(感应器推荐搭配冲水量 0.5L 的产品)



UWN903HB (后进水)
壁挂式节水型小便器
380*390*660mm
感应器另配
(感应器推荐搭配冲水量 0.5L 的产品)



UWN926SHB (后进水)
壁挂式节水型小便器
306*400*590mm
感应器另配
(感应器推荐搭配冲水量 0.5L 的产品)



UWN508VB (上进水)
UWN508HB (后进水)
落地式节水型小便器
340*360*890mm
感应器另配
(感应器推荐搭配冲水量 1.5L 的产品)



UW904SB (上进水)
UW904SHB (后进水)
壁挂式节水型小便器
260*346*675mm
感应器另配



UW103RB (上进水)
UW103RHB (后进水)
壁挂式节水型小便器
337*344*550mm
感应器另配













UWN557SB (上进水)
UWN557HB (后进水)
壁挂式节水型小便器
340*340*580mm
感应器另配
(感应器推荐搭配冲水量 1.5L 的产品)



UWN180VB (上进水)
UWN180HB (后进水)
壁挂式节水型小便器
325*356*595mm
感应器另配
(感应器推荐搭配冲水量 1.5L 的产品)



NEW
USW928HB
壁挂式节水型小便器
260*330*590mm
感应器另配
(感应器推荐搭配冲水量 1.5L 的产品)

| | | | |
|---|--|------------------------|--|
|  | TREF65K2C (干电池) (6L) TREF65U2C (交流电) (6L) | 感应式大便器冲洗阀 185*185mm |  |
|  | TREF75K2C (干电池) (3.3/4.8L) TREF75U2C (交流电) (3.3/4.8L) | 感应式大便器冲洗阀 185*185mm |  |
|  | TREF85K2CA (干电池) (8L) TREF85U2CA (交流电) (8L) | 感应式大便器冲洗阀 185*185mm |  |
|  | DCE602U (干电池) (4.6L) DCE602UE (交流电) (4.6L) | 感应式大便器冲洗阀 |  |
|  | DC603VLC (8L) DC603-1VLC (8L) | 脚踏式大便器冲洗阀 | |
|  | DC603VLC (8L) | 手动式大便器冲洗阀 | |
|  | DCB603VC (8L) | 手动式大便器冲洗阀 (埋墙式) | |

| | | | |
|---|--|--------------------------------------|---|
|  | DUE114UEC (冲水量 1.5L) (交流电) DUE114UKC (冲水量 1.5L) (干电池) | 感应式小便器冲洗阀 (埋入型) 115*115mm 金属面板 |  |
|  | DUE126UEC (冲水量 0.5L) (交流电) DUE126UKC (冲水量 0.5L) (干电池) | 感应式小便器冲洗阀 (埋入型) 115*115mm 金属面板 |  |
|  | DUE114UPEC (冲水量 1.5L) (交流电) DUE114UPKC (冲水量 1.5L) (干电池) | 感应式小便器冲洗阀 (埋入型) 130*130mm 树脂面板 |  |
|  | DUE126UPEC (冲水量 0.5L) (交流电) DUE126UPKC (冲水量 0.5L) (干电池) | 感应式小便器冲洗阀 (埋入型) 130*130mm 树脂面板 |  |
|  | DUE110PBKC (冲水量 1.5L) (直管) DUE110PSKC (冲水量 1.5L) (弯管) | 感应式小便器冲洗阀 (外露式) 50*107*150mm |  |
|  | DU601C (冲水量 1.5L) (直管) DU601SC (冲水量 1.5L) (弯管) | 手动式小便器冲洗阀 (外露式) |  |



适用于新建与改建项目

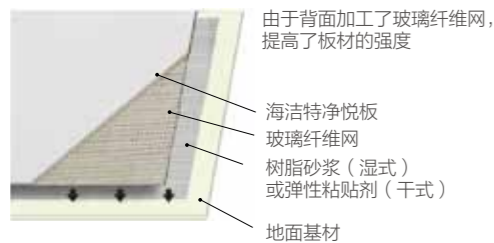

由于背面加工了玻璃纤维网, 提高了板材的强度

海洁特净悦板
玻璃纤维网
树脂砂浆 (湿式)
或弹性粘剂 (干式)
地面基材



灰色 #HU3



黑色 #HH1

TP690#HU3
(灰色PU国产品)

AB690RCN#HH1
(黑色PU进口品)

897mm X 600mm X 5mm
推荐缝宽: 3mm
材质: 炻瓷质
销售 (单位): 片
用途: 小便器下专用

功能性说明

① 污物渗入性比较试验 (本公司实验)

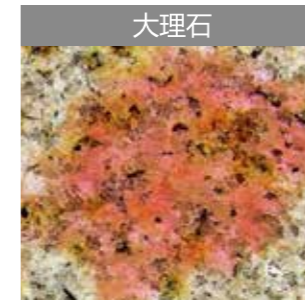

污物渗入板材内部, 便产生斑迹。简单擦拭后即清洁。



试验方法 ① 用颜料滴于表面, 并放置一小时。 ② 用蘸水的布进行擦拭。

② 抗菌防霉比较试验

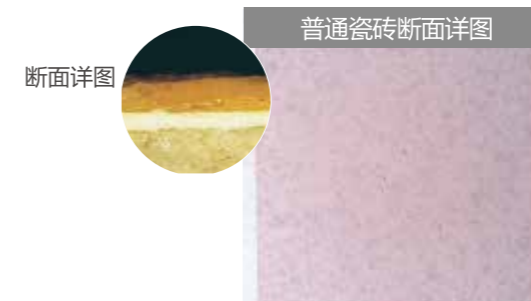

产生了近粉红色的粘泥



几乎没有粘泥出现

试验方法 ① 在试验用砖的表面滴上含有细菌和养分的液体。
② 将试验用砖放置在模拟浴室的潮湿环境中培养。
③ 经过2周时间后观察其变化。

③ 防臭

防臭性能比较试验 (本公司实验)

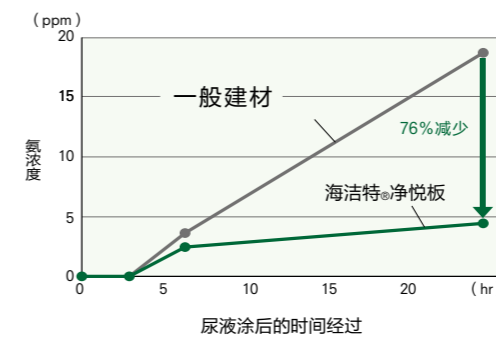

试验方法

将尿液分别滴在不同容器内, 经过两天放置后进行氨浓度的测定。



TYC422W
感应式高速烘手器
300*186*550mm



超快速烘干
双重高速出风
小型化设计
相比上一代烘手器,尺寸更小,适应更多复杂的安装条件
防回风,防水溅
通过合理的空气流动结构设计,有效防止向上的回风和水滴的飞溅



TYC603
感应式高速烘手器
320*164*575mm



TYC323W
感应式高速烘手器
245*154*470mm



TYC323M
感应式高速烘手器
245*154*226mm
(金属制外壳)



TYC123W
感应式暖风烘手器
245*154*226mm

TYC323WF
感应式高速烘手器
245*154*226mm

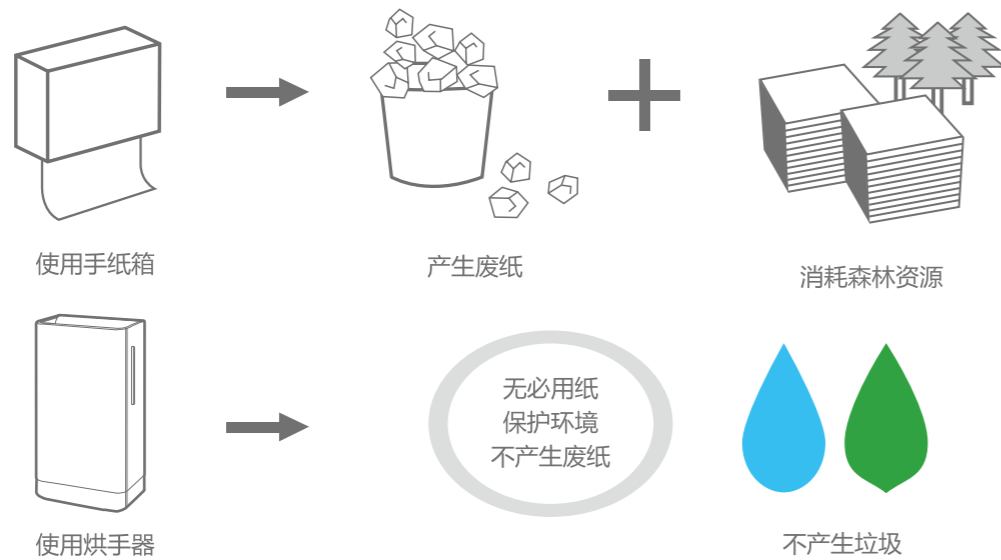

TYC603P
感应式高速烘手器
350*185*1680mm



DS713U
不锈钢大型手纸箱(埋墙式)
350*150*1200mm



DS712U
不锈钢小型手纸箱(埋墙式)
340*140*750mm



SKW322B/SKW322FB

拖布池
560*456*883mm



DL501BN

洗面器用存水弯



DN023

洗面器用排水

可对应颜色
#BN、#PFG、#PBR、#MBL、#PRG、#BGP、
#BTN、#BBR



DL501SR

洗面器用存水弯



DN012

洗面器用排水



DL501P2S

洗面器用存水弯



DN010

洗面器用排水

*仅对应型号：DN023



拉丝镀铬 #BN



抛光法兰金 #PFG



抛光铜色 #PBR



哑光黑 #MBL

*1 本商品包含一部分PVD涂层
*2 本商品是喷涂涂层
(非2022reddot获奖对象)



reddot winner 2022



抛光玫瑰金 #PRG



拉丝石墨灰 #BGP



拉丝钛灰 #BTN



拉丝铜色 #BBR

相同的颜色名称，根据商品材料和材质的不同，颜色也可能存在差异。



坐下时的状态

垂直升降

起身时的状态

垂直升降时

辅助腿脚难以弯曲以及身体前倾后不易站稳的人群以稳定的坐姿完成起身的动作。

保持安稳的坐姿可垂直升降117mm, 并可选择在舒适的位置停止。

起身时的状态

倾斜升降时

适合能够自然弯腰完成起身、落坐动作的人群。

以自然的路径和速度, 配合起身、落坐的动作倾斜升降。便座可在0~11°的角度范围内进行升降, 并可选择在舒适的位置停止。

扶手帮助稳定起身、落坐的动作。需要看护的情况下, 可将扶手收起方便确保足够的看护空间。



EWC151 VC (进口品)
升降式坐便辅助器 (带扶手)
691*656*720mm
691*721*770mm



卫洗丽® C2
TCF2C910GCNV3W
卫洗丽® 智能冲洗坐便盖
470*522*164mm



升降式洗面器
MVZHJ0900CA (洗面器)
900*580*294mm
MXZHJAA (升降装置)
875*654*227mm
+MXZHJBAR (装饰盖板)
877*497*174mm



壁挂式洗面器
MVZHG0900CA (洗面器)
900*580*294mm
+M9ZP40A-2 (支架) 400*155*70mm
+MXZ60022P (排水金具) 302*194*32mm
+MXZ60044 (装饰盖板) 690*297*196mm

卫生



一体型的球型式台盆, 清洗方便, 也非常的卫生。

轻薄的前部



轻薄设计的前部, 便于抓握, 辅助轮椅的接近。

防堵塞排水



防堵塞排水可以更好的拦截食物残渣或垃圾, 方便使用和清洁。

针对可自理、使用扶手或手杖缓慢行动的老人

升降式洗面器 (液压高度调节)

升降高度范围

可供调节的台盆高度, 方便使用者根据个人不同体格、身高、调节使用, 尤其适合使用轮椅的特殊人群。

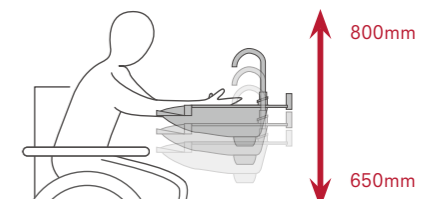

站立使用者 800mm



轮椅使用者 750mm



GT114C6#NW1
多功能 I 型扶手
600mm
离墙面距离 90mm



GT300C6 (进口品)
多功能 I 型扶手 (树脂涂层)
600mm
离墙面距离 90mm
NEW



GT114CL9#NW1
多功能 L 型扶手
700*700mm
离墙面距离 90mm



GT300CL1 (进口品)
多功能 L 型扶手 (树脂涂层)
700*700mm
离墙面距离 120mm
NEW



T114CP5R V2NW (进口品)
人工大理石台面用扶手
635*120mm





T112CP5S V4NW (进口品)
人工大理石台面用扶手 (树脂涂层)
635*120mm



GT300CP1 (进口品)
壁挂式洗面器用扶手 (树脂涂层)
717.5*781*231mm
NEW



T114CP23R V1NW (进口品)
壁挂式洗面器用 P 型扶手
700*740mm



T112CP23 V1NW (进口品)
壁挂式洗面器用 P 型扶手 (树脂涂层)
700*740mm



T114HK7R V2NW (进口品)
单柄坐便器用扶手 (可抬起式)
700*150mm



GT300H7 (进口品)
单柄坐便器用扶手 (可抬起式) (树脂涂层)
707*188mm
NEW



T114CU22R V1NW (进口品)
小便器用扶手
600*550*470mm



GT300CU1 (进口品)
小便器用扶手 (树脂涂层)
600*550*453mm
NEW



EWC520ARS VC (进口品)
多功能护理台
使用时
650*1500*500mm
(护理台 600*1500mm)
折叠后
160*1500*990mm
使用限重: 100kg

收起状态



警告:
本产品请严格按照产品安装说明书内容进行安装。
为了确保产品的安全使用性, 请管理方做好日常检查工作。



GEWC771R
双柄坐便器用扶手(壁挂式)



GEWC772R
双柄坐便器用扶手(落地式)



YHB63FBRC#MW (木纹色)
YHB63FBRC#NW1 (白色)
YHB63FBRC#EL (浅木纹色)
木质功能扶手(含手纸架、收纳盒)
700*120*772mm
※不分左右款式, 墙面两侧均可安装



YHB63NBRC#MW (木纹色)
YHB63NBRC#NW1 (白色)
YHB63NBRC#EL (浅木纹色)
二连手纸架(含收纳盒)
700*120*164mm



YHB63NRC#MW (木纹色)
YHB63NRC#NW1 (白色)
YHB63NRC#EL (浅木纹色)
二连手纸架
700*120*105mm



GYHR600M
不锈钢制 I 型扶手
600mm
离墙面距离 65mm



GYHR800M
不锈钢制 I 型扶手
800mm
离墙面距离 65mm



GYHR86MR
GYHR86ML
不锈钢制 L 型扶手
816*616mm
离墙面距离 65mm



YHB403C#EL (浅木纹色)
YHB403C#MW (木纹色)
YHB403C#NW1 (白色)
木质 I 型扶手
400mm
离墙面距离 60mm



YHB603C#EL (浅木纹色)
YHB603C#MW (木纹色)
YHB603C#NW1 (白色)
木质 I 型扶手
600mm
离墙面距离 60mm



YHB603LC#EL (浅木纹色)
YHB603LC#MW (木纹色)
YHB603LC#NW1 (白色)
木质 L 型扶手
628*628mm
离墙面距离 60mm



YKA41R VC (进口品)
婴儿用更衣台
400*87(使用时200)*560mm



收起状态



YKB10 VIYW (进口品)
I 型扶手
400mm
离墙面距离 100mm



YKA25S VC (进口品)
婴儿床
780*135(使用时560)*1145(使用时950)mm
使用限重: 30kg



收起状态



YKA15S VC (进口品)
婴儿椅
300*250*950mm

警告:
本产品请严格按照产品安装说明书内容进行安装。
为了确保产品的安全使用性, 请管理方做好日常检查工作。
本婴儿床的使用对象为年龄 1 岁以下的婴儿。

警告:
本产品请严格按照产品安装说明书内容进行安装。
为了确保产品的安全使用性, 请管理方做好日常检查工作。
本婴儿椅的使用对象为出生后 5 个月至 2 岁半, 能独立入座的婴儿。



CS300B VB #NW1 (进口品)

分体式坐便器 (幼儿型)
(坑距=255mm)

S300BK VB (进口品)

水箱

TC30C (进口品)

便坐盖

675*340*955mm
EcoMAX 4.6L 节水



YYB10P2S V1YW (进口品)

坐便器用扶手 (大象型)
600*450mm



U310GY VB #NW1 (进口品)
壁挂式节水型小便器 (幼儿型)

340*340*600mm
冲水量:1.5L

DUE138PSKC

感应式小便器冲洗阀

TUP23

小便器用法兰





OTHERS

三千王

浴室取暖干燥机

四季的贴心呵护

| | |
|---|---|
|   暖风 |   凉风 |
| <p>像在阳光里沐浴</p> | <p>夏日里的清凉</p> |
|   干燥 |   换气 |
| <p>告别潮湿心</p> | <p>一整天的清新</p> |



● **快速暖房**
3平方米的浴室，室外温度5℃、浴室内8℃的条件下，调至强效模式5分钟内即可加热至25℃左右。



● **均匀送风**
全方位立体送风，涡轮风扇能均匀烘暖整个浴室，使人感觉更加舒适。



● **清凉舒适**
夏季沐浴时，还能吹出爽快的凉风，同时将室内闷热潮湿的空气排出到室外，让夏天沐浴更清凉。



● **快干，不伤衣物**
清洗后衣物重量5kg、湿度60%的情况下，调至强效模式下只需约160分钟即可烘干衣物。

● **节电干燥**
只需要标准模式30%的电量即可烘干衣物。

● **强力换气**
换气量达到每小时250立方米。快速去除令人烦恼的湿气，实现高效率换气。

● **24H换气、节能、低噪音**
24小时不间断换气，并且保持低能耗低噪音运行，连续一个月24小时不间断运行只需4度电上下。



* 定时功能可设以上四项功能的运行时间



无线遥控
TYB3161CDR
浴室取暖干燥机
外观尺寸：600*300*210mm



控制面板
TYB3161CAR+SHXFE21
浴室取暖干燥机 + 暗埋盒
外观尺寸：600*300*210mm



无线遥控
TYB3161ADR+TYB513
浴室取暖干燥机 + 埋入式安装框
外观尺寸：480*380*209mm



控制面板
TYB3161AAR+SHXFE21+TYB513
浴室取暖干燥机 + 暗埋盒 + 埋入式安装框
外观尺寸：480*380*209mm

诺锐斯特®系列配件 (进口品)



YH63SD VC
YH63SD VC#BN
手纸架 (不含遥控器)
290*260*809mm

G系列配件 (圆形)



| | | | | | |
|---|--|---|--|---|---|
| YH902C YH902C#BN YH902C#MBL*2 手纸架 151*74*90mm | YTT902C YTT902C#BN YTT902C#MBL*2 毛巾环 211*50*53mm | YRH902C YRH902C#BN 衣钩 44*50*68mm | YTS902BC YTS902BC#BN YTS902BC#MBL*2 浴巾架 636*200*69mm | YT902S4C YT902S4C#BN YT902S4C#MBL*2 毛巾架 478*44*25mm | YT902S6C YT902S6C#BN YT902S6C#MBL*2 毛巾架 628*44*25mm |
|---|--|---|--|---|---|



G系列三件套 (圆形)
YS902N3C
包装尺寸: 653*305*152mm
包含:
手纸架 YH902C
毛巾环 YTT902C
浴巾架 YTS902BC

G系列五件套 (圆形)
YS902N5C
包装尺寸: 653*305*152mm
包含:
手纸架 YH902C
毛巾环 YTT902C
浴巾架 YTS902BC
衣钩 YRH902C
毛巾架 YT902S6C

G系列配件 (方形)



| | | | | | |
|-------------------------------|-------------------------------|-----------------------------|----------------------------------|--------------------------------|--------------------------------|
| YH903C 手纸架 148*62*106mm | YTT903C 毛巾环 200*74*47mm | YRH903C 衣钩 24*45*69mm | YTS903BC 浴巾架 628*201*100mm | YT903S4C 毛巾架 474*60*29mm | YT903S6C 毛巾架 624*60*29mm |
|-------------------------------|-------------------------------|-----------------------------|----------------------------------|--------------------------------|--------------------------------|



G系列三件套 (方形)
YS903N3C
包装尺寸: 653*305*152mm
包含:
手纸架 YH903C
毛巾环 YTT903C
浴巾架 YTS903BC

G系列五件套 (方形)
YS903N5C
包装尺寸: 653*305*152mm
包含:
手纸架 YH903C
毛巾环 YTT903C
浴巾架 YTS903BC
衣钩 YRH903C
毛巾架 YT903S6C



*1 本商品包含一部分PVD涂层
*2 本商品是喷涂涂层
(非2022reddot获奖对象)

相同的颜色名称, 根据商品材料和材质的不同, 颜色也可能存在差异。

L系列配件



| | | | |
|---|---|--|--|
| YT411S4C YT411S4C#GP 毛巾架 492*83*19mm NEW | YT411S6C YT411S6C#GP 毛巾架 642*83*19mm NEW | YTT411C YTT411C#GP 毛巾环 166*154*40mm NEW | YH411P1C YH411P1C#GP 手纸架 190*120*75mm NEW |
|---|---|--|--|



| | | | |
|--|--|--|--|
| YH411P1WC YH411P1WC#GP 二连手纸架 290*120*75mm NEW | YRH411C YRH411C#GP 单衣钩 30*30*55mm NEW | YRH411WC YRH411WC#GP 双衣钩 30*30*82mm NEW | YT411W6C YT411W6C#GP 双层毛巾架 642*148*19mm NEW |
|--|--|--|--|



YTS411BC
YTS411BC#GP
浴巾架
642*183*104mm
NEW



YAB411C
YAB411C#GP
便刷
116*153*376mm
NEW

NEW

NEW



| | | | | |
|--|--|---|--|---|
| YH411P1C YH411P1C#GP 手纸架 190*120*75mm | YTT411C YTT411C#GP 毛巾环 166*154*40mm | YTS411BC YTS411BC#GP 浴巾架 642*183*104mm | YRH411C YRH411C#GP 单衣钩 30*30*55mm | YT411S6C YT411S6C#GP 毛巾架 642*83*19mm |
|--|--|---|--|---|



L系列三件套 **NEW**
YS411N3C
YS411N3C#GP
包装尺寸: 806*256*202mm
包含:
手纸架 YH411P1C
YH411P1C#GP
毛巾环 YTT411C
YTT411C#GP
浴巾架 YTS411BC
YTS411BC#GP

L系列五件套 **NEW**
YS411N5C
YS411N5C#GP
包装尺寸: 806*256*202mm
包含:
手纸架 YH411P1C
YH411P1C#GP
毛巾环 YTT411C
YTT411C#GP
浴巾架 YTS411BC
YTS411BC#GP
单衣钩 YRH411C
YRH411C#GP
毛巾架 YT411S6C
YT411S6C#GP





DSP41N
手纸架
40*70*112mm



DSP40N
手纸架
146*87*89mm



YAK201GC
置物架
600*120*32mm



YET400C
YET400C#GP
电热毛巾架
510*227*469mm
NEW



YH181L C
二连手纸架
165*83*55mm



DS716WR
二连手纸架
352*116*98mm



DS715R (喷嘴长度 105mm)
DS715-1R (喷嘴长度 160mm)
皂液器
Ø70*186mm



YH501FMRC #EL (浅木纹色)
手纸架
162*120*105mm



YH600FMRC #EL (浅木纹色)
二连手纸架
320*120*105mm



DSFD01
地漏
100*100mm



DSFD70
地漏
100*100mm



YAT201C
玻璃杯架
67*107*95mm



YAS201C
玻璃皂盒
110*128*45mm



DSFD71
地漏
80*300mm



YAM100LC
化妆镜 (带 LED)
折叠: 360*341*49mm
拉伸: 463*341*49mm
NEW



YAM100C
化妆镜
折叠: 378*290*46.5mm
拉伸: 482*290*46.5mm
NEW



KSA710USR2A#VP
不锈钢水槽 (水嘴内置)
710*460*207mm
NEW



KSA670USL2A#VP
不锈钢水槽 (水嘴内置)
670*470*207mm
NEW



KSAA559USC1A#VP
不锈钢水槽(水嘴内置)
559*457*207mm

NEW



KSAA750DSN0A#VP
不锈钢水槽(水嘴外置)
750*450*207mm

NEW



KSAA600DSN0A#VP
不锈钢水槽(水嘴外置)
600*450*207mm

NEW



KSAA500DSN0A#VP
不锈钢水槽(水嘴外置)
500*450*207mm

NEW



KSAB500USB2A#VP
不锈钢水槽(水嘴内置)
500*430*200mm





NEW







KSAB440DSN0A#VP
不锈钢水槽(水嘴外置)
440*385*180mm

NEW

● : 标准商品
○ : 定制生产商品 (预计交货期请咨询门店销售顾问)

| | | | Cr | BN | PFG | PBR |
|--------|-----|-----|---|---|---|---|
| | | |  |  |  |  |
| 配件 | 手纸架 | 立式 | ● | ● | - | - |
| | | 手纸架 | | | | |
| G 系列配件 | 手纸架 | 方型 | ● | ○ | ○ | ○ |
| | | 圆型 | ● | ● | ○ | ○ |
| | 毛巾环 | 方型 | ● | ○ | ○ | ○ |
| | | 圆型 | ● | ● | ○ | ○ |
| | 衣钩 | 方型 | ● | ○ | ○ | ○ |
| | | 圆型 | ● | ○ | ○ | ○ |
| | 浴巾架 | 方型 | ● | ○ | ○ | ○ |
| | | 圆型 | ● | ○ | ○ | ○ |
| | 毛巾架 | 方型 | ● | ○ | ○ | ○ |
| | | 圆型 | ● | ● | ○ | ○ |

* 该型号为标准商品

| BBR | PRG | MBL | BGP | BTN |
|---|---|---|---|---|
|  |  |  |  |  |
| - | - | - | - | - |
| ○ | ○ | - | ○ | ○ |
| ○ | ○ | ● | ○ | ○ |
| ○ | ○ | - | ○ | ○ |
| ○ | ○ | ● | ○ | ○ |
| ○ | ○ | - | ○ | ○ |
| ○ | ○ | - | ○ | ○ |
| ○ | ○ | ○ | ○ | ○ |
| ○ | ○ | - | ○ | ○ |
| ○ | ○ | ○ YTT902S6C* | ○ | ○ |



坐便器

NEOREST. NX



CS903K V3
P068



洗面器



LW4706B
P137



水嘴



TLP01701C4#BN
P322



TBV02105B#BN
/TBN01001C
P264



TBV02402B#BN
/TBN01001C
P264



TBW07004C#BN
P245



TBW02016C3#BN
/TBW01025C#BN
/TBW01027C#BN
*花洒软管、支架另需购买

P254

花洒



TBW07019C#BN
P257



TBW08009C#BN
P257

浴缸



PJYD2200PW
P296



浴缸水嘴



TBP01301C#BN/TBN01105B
P286

配件



YT902S6C#BN
P352



YTT902C#BN
P352



YH63SD VC#BN
P352



坐便器
NEOREST. WX



CES9E780GCN
P068



洗面器



LW4706B
P137



水嘴



TLP01701C4#BN
P322



花洒

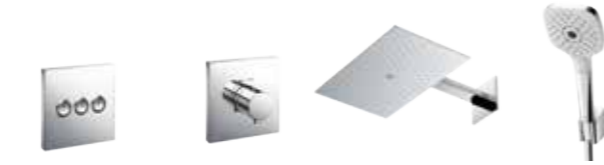

TBV02105B#BN
/TBN01001C
P264

TBV02402B#BN
/TBN01001C
P264

TBW08004C#BN
P245

TBW02015C3#MBL
/TBW08010C#MBL
/TBW01027C#MBL
P254



浴缸



PJYD2200PW#GW
P296



浴缸水嘴



TBP01301C#BN
P286

配件



YH63SD VC#BN
P352



YT902S6C
P352



| 坐便器 | 洗面器 | 水嘴 | 花洒 | 浴缸 | 浴缸水嘴 | 配件 |
|---|---|---|---|---|---|---|
| NEOREST. WX | | | | | | |
|  |  |  |  |  |  |  |
| CES9E780GCN P068 | LW4706B LW4706B#MBL P137 | *TLP01701C4#BN P322 | TBV02105BA#MBL TBV02105B /TBN01001C P264 | TBW02015C3#MBL /TBW08010C#MBL /TBW01027C#MBL P254 | PJYD2200PW#TBL P296 | YH902C#MBL P352 |
|  |  |  |  |  | | |
| * 此颜色为定制生产商品 (预计交货期请咨询门店销售顾问) | | | | | | |



red dot winner 2022
哑光黑 (#MBL)

坐便器
NEOREST. LS



CES8G820GCN
P069



哑光黑 #MBL

洗面器

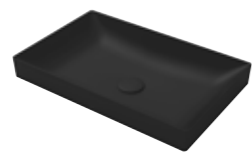

LW4716RB#MBL
P137

水嘴



TLG10303B#MBL
P184



哑光黑 (#MBL)

花洒



TBW02015C3#MBL
/TBW02014C#MBL
/TBW01027C#MBL
P254

*花洒软管、支架另需购买



哑光黑 (#MBL)

TBW08405C#MBL*1
P258



哑光黑 (#MBL)

浴缸



PJY1724WPW#TBL
P300



哑光黑 (#MBL)

浴缸水嘴



TBG10306C#MBL
/TBN01105B
P185



哑光黑 (#MBL)

配件



YH902C#MBL*2
P352



YTT902C#MBL*2
P352

*1 本商品包含一部分PVD涂层
*2 本商品是喷涂涂层
(非2022reddot获奖对象)
相同的颜色名称, 根据商品材料和材质的不同, 颜色也可能存在差异。



坐便器
NEOREST. LS



CES8G320GCN
P070



reddot winner 2022

洗面器



LW1705B
P138

水嘴



TLG09305B
P176



reddot award 2019
winner

花洒



TBV11140C
/TBN11FC0C
P264



reddot winner 2026

TBW160V0C
P257



reddot winner 2026

TBW15EB0C
/TBN01003C
P252



reddot winner 2026

TBW160N0C
P257



reddot winner 2026

TBW15CE0C
P254



reddot winner 2026

配件



YH902C#BN
P352

YT902S6C#BN
P352



| 坐便器 | 洗面器 | 水嘴 | 花洒 | 浴缸 | 浴缸水嘴 | 配件 |
|---|---|---|---|---|---|---|
| NEOREST. AS | | | | | | |
|  |  |  |  |  |  |  |
| CES8C510KCN P070 | LW1716B P138 | TLG02304B P204 | TBV02406B / TBN01001C P264 | PJY1724WPW#GW P300 | TBG02306C/TBN01105B P205 | YH902C P352 |
|  | | |  |  | |  |
| | | | TBW08003C P252 | | | YT902S6C P352 |
| | | | TBW02015C3 / TBW02014C / TBW01027C P254 | | | |
| | | | *花洒软管、支架另需购买 | | | |



坐便器

NEOREST. RS



CES8A510KCN
P070



洗面器



LW1706B
P138

水嘴



TLG01307B
P200



花洒



TBW07403C
P258

TBW01021C3
/TBW01025C
/TBW01027C
*花洒软管、支架另需购买
P254

浴缸



PPY1650HP
P300

浴缸水嘴



TBG11305C
P193

配件



YH902C
P352



YT902S6C
P352



坐便器
G5A



CES7H311KCN
P080

洗面器



LW1735B
P138

水嘴



TLG03305B
P196



花洒



TBW01407C
P258

TBW01021C3
/TBW01025C
/TBW01027C
*花洒软管、支架另需购买
P254

浴缸



PPY1760HP
P306

浴缸水嘴



TBG03202BC
P197

配件



YH902C
P352



YT902S6C
P352



坐便器
W7



CES8A2E2CS
P080



洗面器



PJS05W(#GW/#MW)
P136

水嘴



TLG11306B
P192



浴缸



PJY1744WHPW#GW
P300

浴缸水嘴



TBG11306C/TBN01105B
P193

配件



YH903C
P352



YT903S6C
P352



坐便器
W5



CES7A5CS
P081



洗面器



LW1506B
P139

水嘴



TLG09201BA
P176

花洒



TBG09304BA
/TBN01001C
P177

TBW01004BA
P253

TBW01021C3
/TBW01025C
/TBW01027C
*花洒软管、支架另需购买
P254

TBW01015B
P257

TBW08009C
P257

浴缸



PPY1750HP
P300

浴缸水嘴



TBG09202C
P177

配件



YTS902BC
P352

YT902S6C
P352

YRH902C
P352

YH902C
P352



坐便器
W5



CES7A7CS
P081



洗面器



PJS06W(#GW/#MW)
P136



水嘴



TLG10306B
P184



花洒



TBG10304BA
/TBN01001C
P185

TBW01003BA
P253

TBW02010C3
/TBW02014C
/TBW01027C
*花洒软管、支架另需购买
P254

TBW07018C
P257

TBW08009C
P257

浴缸



PJY1724WHPW#GW
P300



浴缸水嘴



TBG10306C/TBN01105B
P185

配件



YTS903BC
P352

YT903S6C
P352

YRH903C
P352

YH903C
P352



坐便器
G5B



CFS7G511KCN
P080



台盆柜



LDGA090LMD
P124

水嘴



TLS083J0C#GP
P287

镜柜



LMBA090MD
P125

花洒



TBW12480C#GP
P259

配件



YH903C
P352



YET400C#GP
P355



坐便器



CW636REB+TCF4E960KCN
P101

台盆柜



LBEA100RMW/LW840CB
/DZ705
P123

水嘴



TLG12303B
P287

镜柜



LMFC100SPHKD
P129

花洒



TBV01408B
/TBN01001C
P264



TBW07002C
P252



TBW01021C3
/TBW01025C
/TBW01027C
*花洒软管、支架另需购买
P254



TBW01015B
P257



TBW07020C
P257

配件



YH903C
P352



坐便器



CW987SEB+TCF3G460KCN
P101

水嘴



TLG02201BB
P204

花洒



TBG02304BA
/TBN01001C
P205



TBW02003BA
P253



TBW02010C3
/TBW02014C
/TBW01027C
*花洒软管、支架另需购买
P254



TBW07018C
P257



TBW08009C
P257

浴缸



PJY1724WHPW#GW
P300

浴缸水嘴



TBG02306C/TBN01105B
P205

配件



YH903C
P352



YRH903C
P352



YT903S6C
P352



1917

TOTO公司由大仓和亲先生于1917年创立，最初名为东洋陶器株式会社，随后更名为TOTO（东陶机器株式会社）。随着卫生陶瓷产品的广泛销售，TOTO用出色的产品，挑战传统卫生观念，直到今天，TOTO仍在为此努力。

1980

TOTO推出了卫洗丽®智能冲洗坐便盖。卫洗丽以水洗代替纸擦，为全世界消费者带来清洁、舒适的卫浴体验。



1993

推出NEOREST®系列马桶，充分体现了清洁技术的理念，并结合WASHLET及TOTO全系列创新型产品，创造出了拥有高级美学标准和性能质量的卫浴空间。

1995

东陶（中国）有限公司正式成立，经过二十多年的发展，TOTO目前已经在上海、北京、广州、厦门、深圳、南京、重庆、武汉分别设立了8家分公司，并投资建立了8家工厂，中国已成为TOTO在全球最主要的生产基地及重要市场。



1999

搭载“纳米抗污釉面技术”的商品正式发售。“纳米抗污釉面技术”坐便器的内壁采用了超平滑的陶瓷釉面，能够保持长久洁净，经久耐用。

2002

搭载“360°漩涡式冲洗技术”的商品正式发售。“360°漩涡式冲洗技术”实现了节水、静音。360°强劲水流全方位冲洗无棱坐便器内壁。

2009

TOTO首获工业设计造型奖“IF奖”&“红点奖”。“德国IF奖”、“德国reddot红点奖”、“美国IDEA奖”并称为世界三大设计奖，十年来TOTO共37个系列的商品获得IF及红点奖。



2010

搭载“便器内壁电解水除菌技术”的商品正式发售。“便器内壁电解水除菌技术”使用电解水，含有具除菌作用的次氯酸成分。一定时间后，电解除菌水会自动还原成普通水，自然、环保。



2017

在成立100周年之际，百年TOTO向世界展现了革新与努力，挑战永无止境。展望未来，TOTO将带着“革新”的DNA，传承下一个百年。



2018

使用“便器内壁电解水除菌技术”的卫洗丽（包含一体型温水冲洗坐便器），在“GREEN GOOD DESIGN AWARD 2018”评选中入选绿色产品/平面设计部门奖，是本产品继2015、2016年后第三次获得该奖。



2022

NEOREST. LS

搭载“便圈底部电解除菌水技术”的诺锐斯特®智能全自动一体型电子坐便器LS系列荣获工业设计奖“IF奖”&“红点奖”。

2024

NEOREST. WX

发售30周年NEOREST®，带着卫浴产品先驱者的自豪感和使命感，将这卫浴的舒适体验传递至全球，在世界范围内产生更大、更美的涟漪。



2025

截至2025年11月，TOTO卫洗丽®产品累计销售量突破了7000万台。（包含日本国内及海外市场的智能坐便盖类型及卫洗丽®智能一体型坐便器※）。自1980年6月上市销售以来，历经45年5个月，卫洗丽®产品已被广泛应用于住宅、公共设施等各类卫生间中。



顾客至上精神是本公司成立以来一贯遵循的理念。

公司社训

公司社训是向后代传达创始人的思想。是指导TOTO集团企业活动的基本思想。



TOTO集团企业理念

以“公司社训”所传达的理念为基础，向我们所有的利益相关者，展现“作为企业的存在目的”、“业务领域”、“应有的姿态”。

TOTO 集团为了社会的不断发展，将竭尽全力成为世界人民可信赖的企业。

为此

- 创造以“水”为中心的丰富舒适的生活文化
- 通过各种提案，追求超越客户所期待的满足
- 通过不懈的研究开发，提供高品质的产品与服务
- 珍惜有限的资源和能源保护地球环境
- 尊重每个人的个性，创造活跃的工作氛围

为全面赢得顾客及社会的信任，我们立志从三个主要环节肩负起我们的使命。

TOTO 的使命

让大家的
每一天
清洁舒适。

将每一天
打造为环保
的生活。

始终如一地
重视
与人之间的联结。



我们将通过实施全球化环境蓝图来推动这项使命的完成。

| | | | | | | | | | | | |
|-----------------------|-----|------------------------|-----|------------------------|-----|-----------------------|-----|------------------|-----|---------------------|-----|
| TBS02304C..... | 211 | TBV10410C..... | 256 | TBW01401C#MBL*1..... | 258 | TBW08003C..... | 370 | TCF33320GNC..... | 093 | TLE25003C1..... | 324 |
| TBS03001B..... | 213 | TBV10420C#GP..... | 259 | TBW01402C..... | 258 | TBW08003C#MBL*1..... | 252 | TCF33370GNC..... | 093 | TLE25003C2..... | 324 |
| TBS03001B..... | 215 | TBV11120C..... | 264 | TBW01404C..... | 258 | TBW08003C1..... | 252 | TCF34320GNC..... | 092 | TLE25003C3..... | 324 |
| TBS03301B..... | 213 | TBV11120C#MBL..... | 264 | TBW01407C..... | 258 | TBW08003C1#MBL*1..... | 252 | TCF34570GNC..... | 092 | TLE25003C6..... | 324 |
| TBS03302B..... | 213 | TBV11130C..... | 264 | TBW01407C..... | 374 | TBW08004C..... | 245 | TCF3A260KCN..... | 086 | TLE25004C1..... | 324 |
| TBS03303C..... | 213 | TBV11130C#MBL..... | 264 | TBW02001BA..... | 258 | TBW08004C..... | 364 | TCF3A260KCN..... | 087 | TLE25004C2..... | 324 |
| TBS03304C..... | 213 | TBV11140C..... | 264 | TBW02003B1A..... | 253 | TBW08004C#BN..... | 245 | TCF3A260KCN..... | 088 | TLE25004C3..... | 324 |
| TBS04301B..... | 215 | TBV11140C..... | 369 | TBW02003B1B#MBL*2..... | 253 | TBW08004C#BN..... | 362 | TCF3A260KCN..... | 089 | TLE25004C6..... | 324 |
| TBS04302B..... | 215 | TBV11140C#MBL..... | 264 | TBW02003BA..... | 253 | TBW08004C#MBL..... | 364 | TCF3A260KCN..... | 092 | TLE25005C1..... | 324 |
| TBS04303C..... | 215 | TBV11150C..... | 264 | TBW02003BA..... | 386 | TBW08004C#MBL*1..... | 245 | TCF3A460KCN..... | 086 | TLE25005C2..... | 324 |
| TBS04304C..... | 215 | TBV11150C#MBL..... | 264 | TBW02003BB#MBL*2..... | 253 | TBW08004C#PBR..... | 245 | TCF3A460KCN..... | 087 | TLE25005C3..... | 324 |
| TBS06301C..... | 207 | TBV124A0C..... | 256 | TBW02004BA..... | 253 | TBW08008C..... | 255 | TCF3A460KCN..... | 088 | TLE25005C6..... | 324 |
| TBS06302C..... | 207 | TBV124A0C#MBL*1..... | 256 | TBW02004BB#MBL*2..... | 253 | TBW08008C..... | 269 | TCF3A460KCN..... | 089 | TLE26001C1..... | 324 |
| TBS06303C..... | 207 | TBV124B0C..... | 256 | TBW02010C3..... | 254 | TBW08008C..... | 268 | TCF3A460KCN..... | 092 | TLE26001C2..... | 324 |
| TBS06304C..... | 207 | TBV124B0C#MBL*1..... | 256 | TBW02010C3..... | 380 | TBW08009C..... | 257 | TCF3G460KCN..... | 086 | TLE26001C3..... | 324 |
| TBV01101B..... | 265 | TBW01001BA..... | 258 | TBW02010C3..... | 386 | TBW08009C..... | 370 | TCF3G460KCN..... | 087 | TLE26001C6..... | 324 |
| TBV01101B..... | 269 | TBW01001BB#MBL*1..... | 258 | TBW02010C3#MBL*1..... | 254 | TBW08009C..... | 378 | TCF3G460KCN..... | 088 | TLE26002C1..... | 324 |
| TBV01101BA#MBL..... | 265 | TBW01003B1A..... | 253 | TBW02014C..... | 286 | TBW08009C..... | 380 | TCF3G460KCN..... | 089 | TLE26002C2..... | 324 |
| TBV01102B..... | 264 | TBW01003B1B#MBL*2..... | 253 | TBW02014C..... | 370 | TBW08009C..... | 386 | TCF3G460KCN..... | 092 | TLE26002C3..... | 324 |
| TBV01102B..... | 268 | TBW01003BA..... | 253 | TBW02014C..... | 380 | TBW08009C#BN..... | 361 | TCF4E360KCN..... | 086 | TLE26002C6..... | 324 |
| TBV01102B..... | 269 | TBW01003BA..... | 380 | TBW02014C..... | 386 | TBW08009C#MBL*2..... | 257 | TCF4E360KCN..... | 087 | TLE26003C1..... | 324 |
| TBV01102BA#MBL..... | 264 | TBW01003BB#MBL*2..... | 253 | TBW02014C#MBL..... | 366 | TBW08010C..... | 257 | TCF4E360KCN..... | 088 | TLE26003C2..... | 324 |
| TBV01103B..... | 265 | TBW01004BA..... | 253 | TBW02015C3..... | 254 | TBW08010C..... | 268 | TCF4E360KCN..... | 089 | TLE26003C3..... | 324 |
| TBV01103BA#MBL..... | 265 | TBW01004BA..... | 378 | TBW02015C3..... | 370 | TBW08010C..... | 269 | TCF4E360KCN..... | 092 | TLE26003C6..... | 324 |
| TBV01104B..... | 265 | TBW01004BB#MBL*2..... | 253 | TBW02015C3#MBL..... | 362 | TBW08010C#MBL..... | 362 | TCF4E960KCN..... | 086 | TLE26004C1..... | 324 |
| TBV01104BA#MBL..... | 265 | TBW01012B..... | 253 | TBW02015C3#MBL..... | 364 | TBW08010C#MBL..... | 364 | TCF4E960KCN..... | 087 | TLE26004C2..... | 324 |
| TBV01401BA..... | 250 | TBW01013B..... | 253 | TBW02015C3#MBL..... | 366 | TBW08010C#MBL*1..... | 257 | TCF4E960KCN..... | 088 | TLE26004C3..... | 324 |
| TBV01401BA..... | 256 | TBW01013B..... | 271 | TBW02015C3#MBL*1..... | 254 | TBW08010C#PG..... | 257 | TCF4E960KCN..... | 089 | TLE26004C6..... | 324 |
| TBV01401BA#MBL..... | 250 | TBW01013B..... | 275 | TBW02016C3..... | 254 | TBW08010C#PG..... | 278 | TCF4E960KCN..... | 092 | TLE26005C1..... | 324 |
| TBV01401BA#MBL..... | 256 | TBW01015B..... | 257 | TBW02016C3..... | 269 | TBW08010C#PG..... | 279 | TKS06301C..... | 289 | TLE26005C2..... | 324 |
| TBV01402BA..... | 250 | TBW01015B..... | 378 | TBW02016C3..... | 286 | TBW08010C#PG..... | 280 | TKS07301C..... | 289 | TLE26005C3..... | 324 |
| TBV01402BA..... | 256 | TBW01015B..... | 385 | TBW02016C3#BN..... | 360 | TBW08405C..... | 250 | TLE20001C1..... | 322 | TLE26005C6..... | 324 |
| TBV01402BA#MBL..... | 250 | TBW01016B..... | 257 | TBW02016C3#MBL*1..... | 254 | TBW08405C..... | 258 | TLE20001C2..... | 322 | TLE27001C1..... | 319 |
| TBV01402BA#MBL..... | 256 | TBW01016B..... | 266 | TBW03001B..... | 253 | TBW08405C#MBL*1..... | 250 | TLE20001C3..... | 322 | TLE27001C1..... | 324 |
| TBV01406B..... | 264 | TBW01016B..... | 267 | TBW07001C..... | 252 | TBW08405C#MBL*1..... | 258 | TLE20001C6..... | 322 | TLE27001C2..... | 319 |
| TBV01406B..... | 268 | TBW01020C3..... | 254 | TBW07001C#MBL*1..... | 252 | TBW08405C#MBL*1..... | 366 | TLE21001C1..... | 322 | TLE27001C2..... | 324 |
| TBV01406B..... | 269 | TBW01020C3..... | 270 | TBW07001C1..... | 253 | TBW08406C..... | 258 | TLE21001C2..... | 322 | TLE27001C3..... | 319 |
| TBV01406BA#MBL..... | 264 | TBW01020C3..... | 271 | TBW07001C1#MBL*1..... | 253 | TBW08407C..... | 243 | TLE21001C3..... | 322 | TLE27001C3..... | 324 |
| TBV01407B..... | 264 | TBW01020C3..... | 278 | TBW07002C..... | 252 | TBW08407C#BN..... | 243 | TLE21001C6..... | 322 | TLE27001C6..... | 319 |
| TBV01407B..... | 266 | TBW01020C3..... | 279 | TBW07002C..... | 385 | TBW08408C..... | 243 | TLE22001C1..... | 323 | TLE27001C6..... | 324 |
| TBV01407BA#MBL..... | 264 | TBW01020C3..... | 280 | TBW07002C#MBL*1..... | 252 | TBW08408C..... | 243 | TLE22001C2..... | 323 | TLE28001C1..... | 319 |
| TBV01408B..... | 264 | TBW01020C3#MBL*1..... | 254 | TBW07002C1..... | 253 | TBW09000C1..... | 255 | TLE22001C3..... | 323 | TLE28001C1..... | 324 |
| TBV01408B..... | 267 | TBW01020C3#PG..... | 278 | TBW07002C1#MBL*1..... | 253 | TBW09000C2..... | 254 | TLE22001C6..... | 323 | TLE28001C2..... | 319 |
| TBV01408B..... | 385 | TBW01020C3#PG..... | 279 | TBW07003C..... | 252 | TBW09010C1..... | 254 | TLE22001C3..... | 323 | TLE28001C2..... | 324 |
| TBV01408BA#MBL..... | 264 | TBW01020C3#PG..... | 280 | TBW07003C..... | 267 | TBW09010C1#GP..... | 254 | TLE23001C1..... | 323 | TLE28001C2..... | 319 |
| TBV02101B..... | 265 | TBW01021C3..... | 254 | TBW07003C..... | 267 | TBW09010C2..... | 255 | TLE23001C2..... | 323 | TLE28001C3..... | 324 |
| TBV02101B..... | 269 | TBW01021C3..... | 254 | TBW07003C#MBL*1..... | 252 | TBW10000C1..... | 253 | TLE23001C3..... | 323 | TLE28001C3..... | 324 |
| TBV02101BA#MBL..... | 265 | TBW01021C3..... | 268 | TBW07003C1..... | 253 | TBW10010C1..... | 253 | TLE23001C6..... | 323 | TLE28001C6..... | 319 |
| TBV02102B..... | 264 | TBW01021C3..... | 280 | TBW07003C1#MBL*1..... | 253 | TBW10020C1..... | 253 | TLE23002C1..... | 323 | TLE28001C6..... | 324 |
| TBV02102B..... | 268 | TBW01021C3..... | 372 | TBW07004C..... | 245 | TBW10030C1..... | 253 | TLE23002C2..... | 323 | TLE30001C5..... | 324 |
| TBV02102B..... | 269 | TBW01021C3..... | 374 | TBW07004C#BN..... | 360 | TBW11440C..... | 259 | TLE23002C3..... | 323 | TLE31001C5..... | 324 |
| TBV02102BA#MBL..... | 264 | TBW01021C3..... | 378 | TBW07004C#MBL*2..... | 245 | TBW11450C..... | 259 | TLE23002C6..... | 323 | TLG01201BB..... | 200 |
| TBV02103B..... | 265 | TBW01021C3..... | 385 | TBW07004C#PBR..... | 245 | TBW11460C..... | 259 | TLE23003C1..... | 323 | TLG01301B..... | 200 |
| TBV02103BA#MBL..... | 265 | TBW01021C3#MBL*1..... | 254 | TBW07004C#PFG..... | 245 | TBW11470C..... | 259 | TLE23003C2..... | 323 | TLG01303B..... | 200 |
| TBV02104B..... | 265 | TBW01021C3#PG..... | 280 | TBW07018C..... | 257 | TBW12400C..... | 259 | TLE23003C3..... | 323 | TLG01304B..... | 200 |
| TBV02104BA#MBL..... | 265 | TBW01025C..... | 270 | TBW07018C..... | 380 | TBW12400C#GP..... | 259 | TLE23003C6..... | 323 | TLG01306B..... | 200 |
| TBV02105B..... | 264 | TBW01025C..... | 271 | TBW07018C..... | 386 | TBW12410C..... | 259 | TLE23004C1..... | 323 | TLG01307B..... | 200 |
| TBV02105B..... | 272 | TBW01025C..... | 272 | TBW07019C..... | 257 | TBW12480C#GP..... | 259 | TLE23004C2..... | 323 | TLG01307B..... | 372 |
| TBV02105B..... | 268 | TBW01025C..... | 273 | TBW07019C..... | 370 | TBW12480C#GP..... | 383 | TLE23004C3..... | 323 | TLG01308B..... | 200 |
| TBV02105B..... | 269 | TBW01025C..... | 275 | TBW07019C#BN..... | 361 | TBW13020C2..... | 259 | TLE23004C6..... | 323 | TLG01309BB..... | 200 |
| TBV02105B..... | 364 | TBW01025C..... | 372 | TBW07019C#MBL*1..... | 257 | TBW13030C2..... | 259 | TLE23005C1..... | 323 | TLG01310C..... | 200 |
| TBV02105B#BN..... | 360 | TBW01025C..... | 374 | TBW07020C..... | 257 | TBW13040C2..... | 259 | TLE23005C2..... | 323 | TLG01311C..... | 200 |
| TBV02105B#BN..... | 362 | TBW01025C..... | 378 | TBW07020C..... | 266 | TBW13050C2..... | 259 | TLE23005C3..... | 323 | TLG02201BB..... | 204 |
| TBV02105BA#MBL..... | 364 | TBW01025C..... | 385 | TBW07020C..... | 267 | TBW14SC0C..... | 258 | TLE23005C6..... | 323 | TLG02201BB..... | 386 |
| TBV02105BA#MBL*2..... | 264 | TBW01025C#BN..... | 360 | TBW07020C..... | 385 | TBW14SC0C#MBL*1..... | 258 | TLE24001C1..... | 323 | TLG02201BB#BN..... | 204 |
| TBV02401B..... | 264 | TBW01026C..... | 266 | TBW07020C#MBL*2..... | 257 | TBW14SD0C..... | 258 | TLE24001C2..... | 323 | TLG02301B..... | 204 |
| TBV02401B..... | 268 | TBW01026C..... | 267 | TBW07021C..... | 257 | TBW14SD0C#MBL*1..... | 258 | TLE24001C3..... | 323 | TLG02301B#BN..... | 204 |
| TBV02401B..... | 269 | TBW01026C..... | 272 | TBW07021C#MBL*1..... | 257 | TBW14UC0C..... | 258 | TLE24001C6..... | 323 | TLG02303B..... | 204 |
| TBV02401BA#MBL..... | 264 | TBW01026C..... | 273 | TBW07032C..... | 255 | TBW14UC0C#MBL*1..... | 258 | TLE24002C1..... | 323 | TLG02303B#BN..... | 204 |
| TBV02402B..... | 264 | TBW01026C..... | 275 | TBW07032C..... | 267 | TBW14UD0C..... | 258 | TLE24002C2..... | 323 | TLG02304B..... | 204 |
| TBV02402B..... | 268 | TBW01027C..... | 268 | TBW07032C..... | 272 | TBW14UD0C#MBL*1..... | 258 | TLE24002C3..... | 323 | TLG02304B..... | 370 |
| TBV02402B..... | 269 | TBW01027C..... | 269 | TBW07032C..... | 273 | TBW14WC0C..... | 258 | TLE24002C6..... | 323 | TLG02304B#BN..... | 204 |
| TBV02402B..... | 364 | TBW01027C..... | 270 | TBW07032C..... | 275 | TBW14WC0C#MBL*1..... | 258 | TLE24003C1..... | 319 | TLG02306B..... | 204 |
| TBV02402B#BN..... | 360 | TBW01027C..... | 271 | TBW07032C1..... | 255 | TBW15AB0C..... | 252 | TLE24003C1..... | 323 | TLG02306B#BN..... | 204 |
| TBV02402B#BN..... | 362 | TBW01027C..... | 286 | TBW07033C..... | 255 | TBW15AB0C#MBL*1..... | 252 | TLE24003C2..... | 319 | TLG02307B..... | 204 |
| TBV02402BA#MBL..... | 264 | TBW01027C..... | 370 | TBW07033C..... | 266 | TBW15CB0C..... | 252 | TLE24003C2..... | 323 | TLG02307B#BN..... | 204 |
| TBV02402BA#MBL..... | 364 | TBW01027C..... | 372 | TBW07033C1..... | 255 | TBW15CB0C#MBL*1..... | 252 | TLE24003C3..... | 319 | TLG02308B..... | 204 |
| TBV02403B..... | 264 | TBW01027C..... | 374 | TBW07403C..... | 258 | TBW15CE0C..... | 254 | TLE24003C3..... | 323 | TLG02308B#BN..... | 204 |
| TBV02403B..... | 266 | TBW01027C..... | 378 | TBW07403C..... | 372 | TBW15CE0C..... | 369 | TLE24003C6..... | 319 | TLG02309BB..... | 204 |
| TBV02403BA#MBL..... | 264 | TBW01027C..... | 380 | TBW07404C..... | 250 | TBW15CE0C#MBL*1..... | 254 | TLE24003C6..... | 323 | TLG02309BB#BN..... | 204 |
| TBV02404B..... | 264 | TBW01027C..... | 385 | TBW07404C..... | 258 | TBW15DE0C..... | 254 | TLE24004C1..... | 323 | TLG02310C..... | 204 |
| TBV02404B..... | 267 | TBW01027C..... | 386 | TBW07411C..... | 250 | TBW15DE0C#MBL*1..... | 254 | TLE24004C2..... | 323 | TLG02310C#BN..... | 204 |
| TBV02404BA#MBL..... | 264 | TBW01027C#BN..... | 360 | TBW07411C..... | 260 | TBW15EBOC..... | 252 | TLE24004C3..... | 323 | TLG02311C..... | 204 |
| TBV02405B..... | 264 | TBW01027C#MBL..... | 362 | TBW08001C..... | 252 | TBW15EBOC..... | 369 | TLE24004C6..... | 323 | TLG02311C#BN..... | 204 |
| TBV02405B..... | 266 | TBW01027C#MBL..... | 364 | TBW08001C#MBL*1..... | 252 | TBW15EBOC#MBL*1..... | 252 | TLE24005C1..... | 323 | TLG03201BB..... | 196 |
| TBV02405BA#MBL*2..... | 264 | TBW01027C#MBL..... | 366 | TBW08001C1..... | 252 | TBW160NOC..... | 257 | TLE24005C1..... | 323 | TLG03201BB#MBL..... | 196 |
| TBV02406B..... | 264 | TBW01027C#PG..... | 278 | TBW08001C1#MBL*1..... | 252 | TBW160NOC..... | 369 | TLE24005C3..... | 323 | TLG03301B..... | 196 |
| TBV02406B..... | 267 | TBW01027C#PG..... | 279 | TBW08002C..... | 252 | TBW160NOC#MBL*1..... | 257 | TLE24005C6..... | 323 | TLG03301B#MBL..... | 196 |
| TBV02406B..... | 370 | TBW01027C#PG..... | 280 | TBW08002C..... | 273 | TBW160VOC..... | 257 | TLE25001 | | | |

CONTACT US

北京营业所

北京市朝阳区光华路1号
北京嘉里中心北楼1915室
电话：010-8529-8600
传真：010-8529-8670

南京营业所

南京市长江路188号
德基大厦17层A座
电话：025-8681-9331
传真：025-8681-9330

上海营业所

上海市南京西路1515号
静安嘉里中心办公楼一座5楼
电话：021-6270-1010
传真：021-6270-3099

厦门营业所

厦门市厦禾路189号
银行中心大厦2107室
电话：0592-239-4400
传真：0592-239-4411

广州营业所

广州市越秀区侨光西路13号星寰国际
商业中心写字楼T1栋1501-1503室
电话：020-8666-0003
传真：020-8666-3257

深圳营业所

深圳市深南东路5016号
京基一百大厦A座5101-03室
电话：0755-8217-2579
传真：0755-8217-4449

重庆营业所

重庆市渝中区五一路99号B塔
平安国际金融中心2205室
电话：023-6373-1010
传真：023-6373-7070

武汉营业所

湖北省武汉市江岸区中山大道1505号
15楼128室
电话：18627977466

东陶（香港）有限公司

香港湾仔骆克道3号
11字楼1101室
电话：00852-2861-3177
传真：00852-2861-3563

TOTO

东陶（中国）有限公司
www.toto.com.cn

售后服务热线 / 卫洗丽咨询热线：800-820-9787(固定电话，免费) 400-820-9787(手机拨打)

*龙头、配件以外的定制生产商品及预计交货期请询问门店销售顾问